

TOSHIBA

Leading Innovation >>>

CATALOG 2018-7

Air-cooled Inverter Modular Chiller
for Diverse Customer Needs

UNIVERSAL SMART X *EDGE series*



Better Air Solutions

Made-in-Japan
All-new innovative chiller system



Better Air Solutions



Through our commitment to world-class **efficiency**, versatile **scalability** and leading **quality**, Toshiba Air Conditioning advances leading-edge technologies to find the most forward-thinking solutions possible for your world.

UNIVERSAL SMART X EDGE series ***60HP model / 70HP model***

The EDGE series offers new function with the world's highest class of large-capacity DC inverter rotary compressor.



UNIVERSAL SMART X *EDGE* series line-up

Internal inverter pump

Model	Use	Type	Power supply	Page
60HP	Cooling-only	Standard	3-phase 3-wire 50/60Hz 380V / 400V / 415V	9
		High-EER		
	Heat pump	Standard	3-phase 3-wire 60Hz 440V	10
		High-EER		
70HP	Cooling-only	Standard	3-phase 3-wire 50/60Hz 380V / 400V / 415V	11
		High-EER		
	Heat pump	Standard	3-phase 3-wire 60Hz 440V	12
		High-EER		

Pumpless

Model	Use	Type	Power supply	Page
60HP	Cooling-only	Standard	3-phase 3-wire 50/60Hz 380V / 400V / 415V	13
		High-EER		
	Heat pump	Standard	3-phase 3-wire 60Hz 440V	14
		High-EER		
70HP	Cooling-only	Standard	3-phase 3-wire 50/60Hz 380V / 400V / 415V	15
		High-EER		
	Heat pump	Standard	3-phase 3-wire 60Hz 440V	16
		High-EER		

View of models

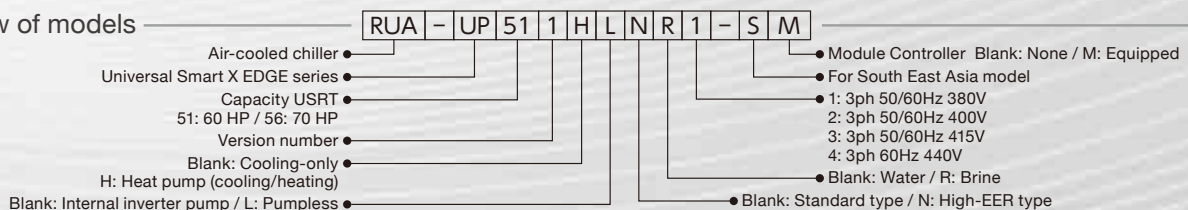



7 Smart features

1 **60HP model** Highest-Class of Energy Saving in the Industry

Standard type

With optimum tuning of the compressor and adopting a highly-improved design of a heat exchanger and refrigerant cycle, UNIVERSAL SMART X has achieved high efficiency **IPLV 6.4***.

High-EER type

A higher efficiency **IPLV6.4*** has been achieved.

By optimizing the water dispersion nozzle and placement, dispersion volume per cooling capacity (kW) has been reduced 17% from the current UNIVERSAL SMART X.

*1 The indicated value for IPLV (cooling IPLV) is based on the AHRI550-590 'Water Chilling Unit'.

2 **70HP model** Single module unit, largest chiller in its class

Space-saving installation

Maximum capacity of 70hp (200kW) allows it to be installed in areas with limited space. This unit saves space and maximizes power.

UNIVERSAL SMART X 50HP

Seven 150kW units = 1050kW



70HP(56RT) model

Five 200kW units = 1000kW



3 World's largest capacity*² DC inverter twin rotary compressor

Improving system performance with the installation of a newly-developed high-capacity DC-inverter rotary compressor—the largest in its class.

*2 As of December 2016. According to a study by Toshiba Carrier on AC heat-source pumps (AC-style chiller).

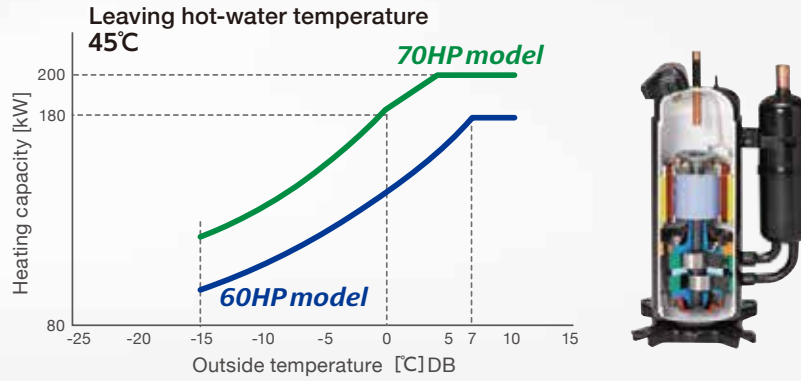

4 Compact design with Edge shape

Installation friendly

In addition to the X Frame, which also has features of our module-type chiller, a unique Edge shape has been adopted to make the piping space more accessible.

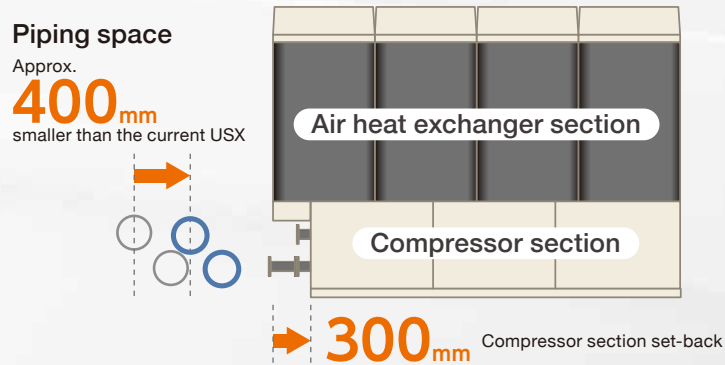

Small footprint

Through the adopting of Edge shape in the compact design, the piping space has been reduced by 400mm smaller than the current UNIVERSAL SMART X, and the workability and serviceability have been improved.

The foundation base area has been reduced to 1000mm x 3000mm, and can be easily adapted to overhauls.

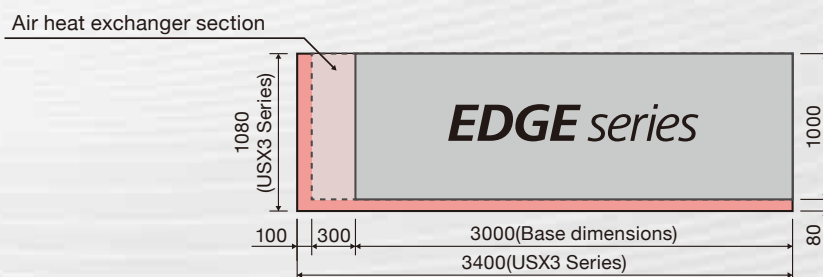



UNIVERSAL SMART X *EDGE* series

60HP model / 70HP model

5 Highly-reliable module unit system

Each module unit has independent refrigerant cycle, providing risk-diversification.

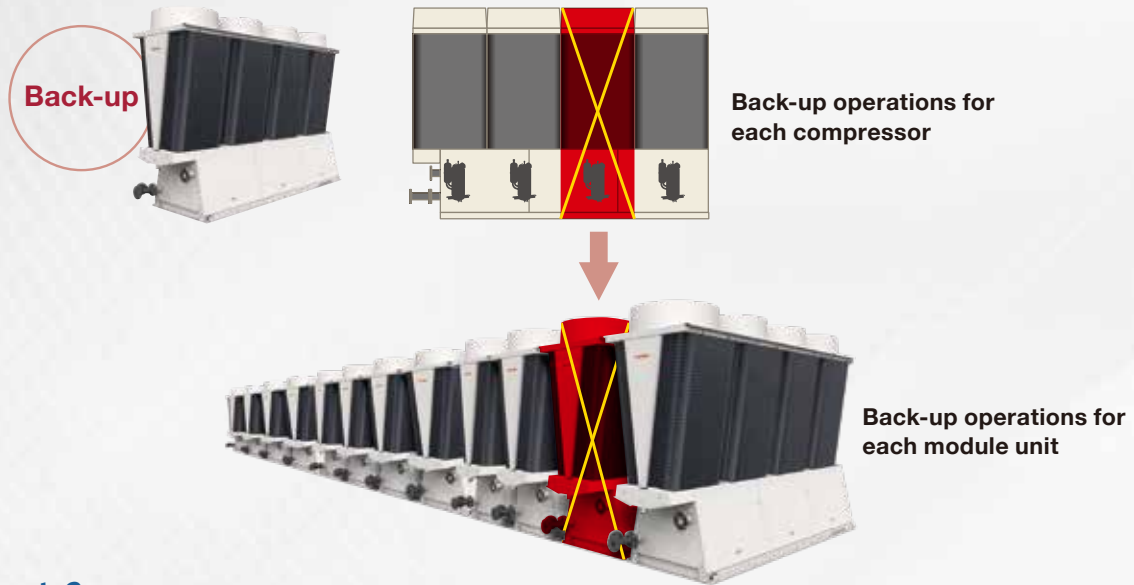

And also...

Defrosting operation is also performed for each compressor.

Make use of the back-up function to carry out distributed defrost in the module units, and control a reduction in temperature of the hot-water.

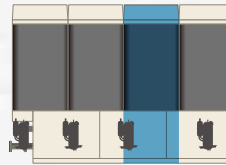
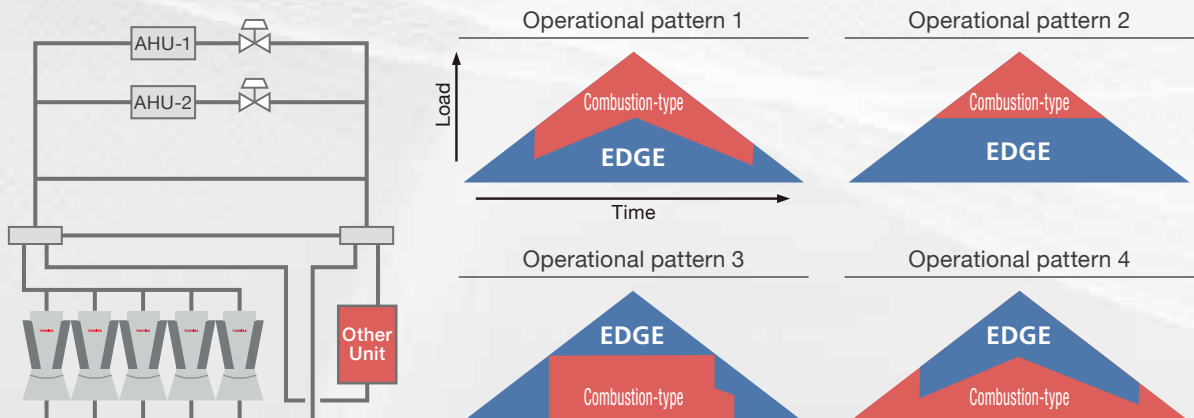

Photo: Defrosting operation demonstration

6 Flexible to various energies

To be released in 2019

With an additional function of group controller, UNIVERSAL SMART X EDGE series can operate with other heat sources, such as a water-cooled chiller or an absorption chiller. You can select the optimum operational pattern to maximize energy savings in response to energy costs and the seasons.



7 Flexible control of up to 8960 horsepower

Up to 128 UNIVERSAL SMART X EDGE series module units can be combined and operated together.

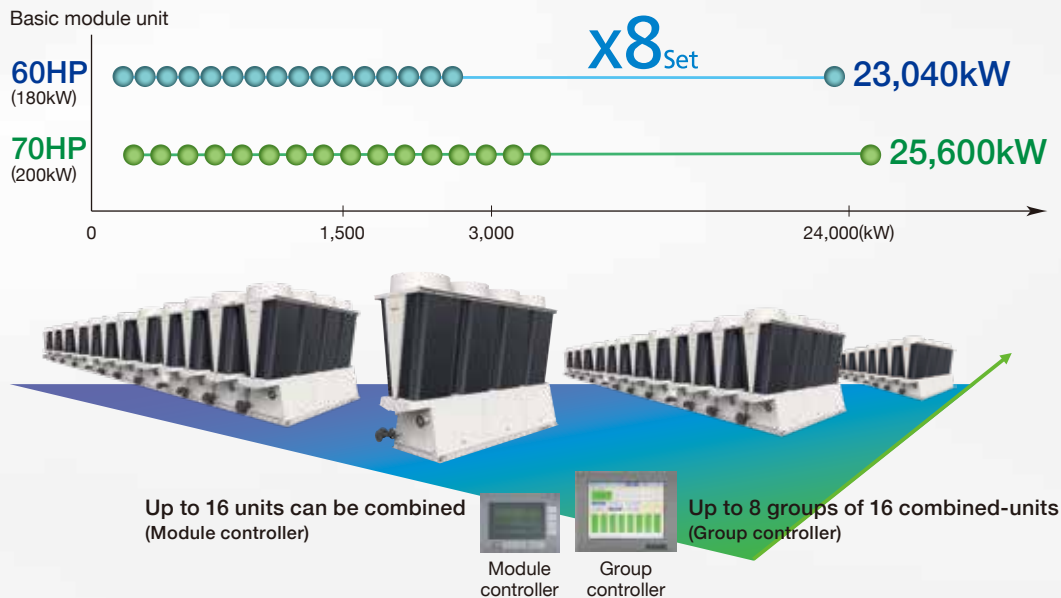

■ Wifi data analysis

Wireless LAN function comes standard in the module controller. Dedicated application collects data, like power consumption and inlet/outlet temperature, on a device, like a tablet, allowing for the study of optimal operations.

*The machine is not designed for use in all regions. Please contact a representative for details.

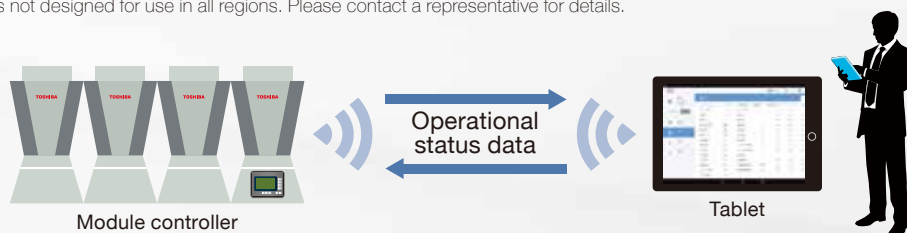

Energy saving

Pursuit of system performance

(flow optimizer control/harmonic suppression functionality/power factor of 99%)

■ Variable water flow control

Internal inverter pump reduces transfer power with variable water flow and water pressure control, which adjusts water flow volume and water pressure according to each load and with a bypass flow 0 control system, which reduces wasteful water flow.

■ No harmonic filter / Power factor 99%

Our unique PWM (Pulse Width Modulation) Converter allows no Harmonic Filter treatment on site. Also, a power factor of 99% contributes to a reduction in the size of the power supply cable, circuit breaker, and the installation cost.

60HP model

Cooling-only

	Standard type				High-EER type					
	380V 60HP	400V 60HP	415V 60HP	440V 60HP	380V 60HP	400V 60HP	415V 60HP	440V 60HP		
Model (A single module unit)	RUA-UP5111-S	RUA-UP5112-S	RUA-UP5113-S	RUA-UP5114-S	RUA-UP511N1-S	RUA-UP511N2-S	RUA-UP511N3-S	RUA-UP511N4-S		
Cooling capacity (Note 1) (kW)	180				180					
Exterior	Unit color: Silky shade (Munsell 1Y8.5/0.5)									
	Dimensions	Height (mm)	2,350			2,350				
		Width (Note 2) (mm)	1,000			1,000				
Depth (Note 2) (mm)	3,300			3,300						
Shipping weight (kg)	1,286				1,298					
Operating weight (kg)	1,322				1,334					
Power supply (Note 1-3)	3-phase 3-wire 50/60Hz 380V/400V/415V, 3-phase 3-wire 60Hz 440V				3-phase 3-wire 50/60Hz 380V/400V/415V, 3-phase 3-wire 60Hz 440V					
Reference current for power supply design (Note 4-5) (A)	98				98					
Electrical data (Note 1-6)	Cooling	Nominal current (A)	86.9 (89.1)	82.5 (84.7)	79.5 (81.6)	75.0 (77.0)	58.5 (60.6)	55.6 (57.6)	53.6 (55.5)	50.5 (52.3)
		Nominal input (kW)	56.6 (58.1)				38.1 (39.5)			
		EER	3.18 (3.10)				4.72 (4.56)			
		Power factor (Note 7) (%)	99				99			
IPLV (With a 5°C difference) (Note 8)	6.4				6.4					
Compressor	Type	Hermetic rotary x 4				Hermetic rotary x 4				
	Model name	RA1000A4F-11UC				RA1000A4F-11UC				
	Motor output x number of units (kW)	12.4 x 4				8.2 x 4				
	Type of start	Inverter starter				Inverter starter				
	Case heater (W)	37 x 4				37 x 4				
Compressor oil	Type	RB74AF				RB74AF				
	Charge (L)	2.0 x 4				2.0 x 4				
Condenser coil - air side	Plate fin coil				Plate fin coil					
Fan	Type	Propeller fan				Propeller fan				
	Air quantity (m ³ /min)	1,230 (maximum)				1,230 (maximum)				
	Type of start	Inverter starter				Inverter starter				
Water spray system (Note 9)	Motor output x number of units (kW)	1.2 x 4				1.2 x 4				
	Water spray volume (L/min)	—				13.6 x 1				
	Supply water pressure (Note 10) (MPa)	—				0.2				
	Control	—				Continuous water spraying when outside temperature exceeds setting and compressor capacity exceeds setting				
Pumps (Note 4)	Motor output (kW)	1.5				1.5				
	Type	Centrifugal pump				Centrifugal pump				
	Flow control	Inverter				Inverter				
	Maximum current (A)	3.1				3.1				
Maximum input (kW)	2.0				2.0					
Cooler - water side (Note 11)	Braze plate heat exchanger (SUS316 equivalent)				Braze plate heat exchanger (SUS316 equivalent)					
Refrigerant	Type	R410A				R410A				
	R410 charge (kg)	10.2 x 4				10.2 x 4				
	Control	Electric expansion valve				Electric expansion valve				
Capacity control steps (Note 12) (%)	0.5 ~ 100				0.5 ~ 100					
Operation control	Microprocessor control based on leaving water temperature and temperature difference									
Protective device	High-pressure switch, Over current protection, Inverter overload protection (compressor, fan, pump), Crankcase heater, Open-phase protection, Microprocessor control (compressor time guards, freeze protection, low flow rate, discharge gas overheat protection), low pressure cutout, thermistor error, high water pressure error									
Piping diameters	Cold/Hot water inlet (A)	65 flange x 1 (JIS10K)				65 flange x 1 (JIS10K)				
	Cold/Hot water outlet (A)	65 flange x 1 (JIS10K)				65 flange x 1 (JIS10K)				
	Coil drain (A)	PT40 screw x 1				PT40 screw x 1				
Sound level (Note 13)	Control box side (dBA)	72.9				72.9				
	Coil side (dBA)	74.0				74.0				
	Water piping side (dBA)	70.2				70.2				
Required products sold separately	Module controller (MC) (include external sensor x 2) (Note 14)									

(Note 1) Rated conditions, such as capacity, electrical data, and standard flow rate are as follows.
 For cooling : 14°C entering water (EWT), 7°C leaving water (LWT), 35°CDB/24°CWD outdoor air (OAT) and 21°C feed-water temperature
 For heating : 38°C entering water (EWT), 45°C leaving water (LWT), 7°CDB/6°CWD outdoor air (OAT)
 Numbers in parenthesis indicate values for a difference of 5°C.
 For cooling: 12°C entering water (EWT), 7°C leaving water (LWT)
 For heating: 38°C entering water (EWT), 45°C leaving water (LWT)
 Same capacities, outdoor air temperature, and supplied water temperature (only for High EER type) as indicated above.
 Design water flow rate must be within the range of 5 to 10°C water temperature differences. Capacities and performance values are based on AHRI550-590.

(Note 2) Dimensions do not include projections of water pipe connections.
 (Note 3) Even when there is a fluctuation in supply voltage, do not exceed ±10% and keep imbalances between the supply voltages within 2%.
 (Note 4) Output of the integrated pump can change depending on the outlet pump head required to comply with the indent. The power supply design at that time differs from those of a standard pump.
 (Note 5) Always install an earth leakage circuit breaker. This machine includes an inverter, so please use a high-frequency-compatible product to prevent malfunction.
 (Note 6) Note that electrical data do not include internal pump.
 (Note 7) Power factors may vary depending on site conditions.
 (Note 8) The indicated value for IPLV (Integrated Part Load Value, cooling) is based on the AHRI550-590 "Water Chilling Unit".
 (Note 9) The supply water quality may cause scales and other matter to adhere to the coil surface. If necessary, install a water softener on the supply water side. (Provided locally)
 (Note 10) Adjust the flow rate to become close to this supply water pressure with the manual flow adjustment valve on the water spray system inlet. If sufficient supply water pressure is not available, install a pressure pump. (Provided locally)
 (Note 11) Working pressure : below 0.7 MPa.
 (Note 12) Range of capacity control sometimes can vary depending on the unit's operating condition.
 (Note 13) (Measurement position: Distance of 1.0m, height of 1.5m) The on-site sound level will be higher due to the affection of back noise and sound reflection.
 (Note 14) The external sensor's lead wire length is 30 m.

Specifications Internal inverter pump

60HP model

Heat pump

	Standard type				High-EER type					
	380V 60HP	400V 60HP	415V 60HP	440V 60HP	380V 60HP	400V 60HP	415V 60HP	440V 60HP		
Model (A single module unit)	RUA-UP511H1-S	RUA-UP511H2-S	RUA-UP511H3-S	RUA-UP511H4-S	RUA-UP511HN1-S	RUA-UP511HN2-S	RUA-UP511HN3-S	RUA-UP511HN4-S		
Cooling capacity (Note 1) (kW)	180				180					
Heating capacity (Note 1) (kW)	180				180					
Exterior	Unit color: Silky shade (Munsell 1Y8.5/0.5)									
	Dimensions	Height (mm)	2,350			2,350				
		Width (Note 2) (mm)	1,000			1,000				
		Depth (Note 2) (mm)	3,300			3,300				
Shipping weight (kg)	1,323				1,335					
Operating weight (kg)	1,359				1,371					
Power supply (Note 1-3)	3-phase 3-wire 50/60Hz 380V/400V/415V, 3-phase 3-wire 60Hz 440V				3-phase 3-wire 50/60Hz 380V/400V/415V, 3-phase 3-wire 60Hz 440V					
Reference current for power supply design (Note 4-5) (A)	98				98					
Electrical data (Note 6)	Cooling	Nominal current (A)	86.9 (89.1)	82.5 (84.7)	79.5 (81.6)	75.0 (77.0)	58.5 (60.6)	55.6 (57.6)	53.6 (55.5)	50.5 (52.3)
		Nominal input (kW)	56.6 (58.1)				38.1 (39.5)			
		EER	3.18 (3.10)				4.72 (4.56)			
		Power factor (Note 7) (%)	99				99			
	Heating	Nominal current (A)	82.4 (83.5)	78.3 (79.3)	75.5 (76.4)	71.2 (72.1)	82.4 (83.5)	78.3 (79.3)	75.5 (76.4)	71.2 (72.1)
		Nominal input (kW)	53.7 (54.4)				53.7 (54.4)			
		COP	3.35 (3.31)				3.35 (3.31)			
		Power factor (Note 7) (%)	99				99			
IPLV (With a 5°C difference) (Note 8)	6.4				6.4					
Compressor	Type	Hermetic rotary x 4				Hermetic rotary x 4				
	Model name	RA1000A4F-11UC				RA1000A4F-11UC				
	Motor output x number of units (kW)	12.4 x 4				11.9 x 4				
	Type of start	Inverter starter				Inverter starter				
	Case heater (W)	37 x 4				37 x 4				
Compressor oil	Type	RB74AF				RB74AF				
	Charge (L)	2.0 x 4				2.0 x 4				
Condenser coil - air side	Plate fin coil				Plate fin coil					
Fan	Type	Propeller fan				Propeller fan				
	Air quantity (m ³ /min)	1,230 (maximum)				1,230 (maximum)				
	Type of start	Inverter starter				Inverter starter				
	Motor output x number of units (kW)	1.2 x 4				1.2 x 4				
Water spray system (Note 9)	Water spray volume (L/min)	—				13.6 x 1				
	Supply water pressure (Note 10) (MPa)	—				0.2				
	Control	—				Continuous water spraying when outside temperature exceeds setting and compressor capacity exceeds setting				
Pump (Note 4)	Motor output (kW)	1.5				1.5				
	Type	Centrifugal pump				Centrifugal pump				
	Flow control	Inverter				Inverter				
	Maximum current (A)	3.1				3.1				
	Maximum input (kW)	2.0				2.0				
Cooler - water side (Note 11)	Braze plate heat exchanger (SUS316 equivalent)				Braze plate heat exchanger (SUS316 equivalent)					
Refrigerant	Type	R410A				R410A				
	R410 charge (kg)	10.6 x 4				10.6 x 4				
	Control	Electric expansion valve				Electric expansion valve				
Capacity control steps (Note 12) (%)	0.5 ~ 100				0.5 ~ 100					
Operation control	Microprocessor control based on leaving water temperature and temperature difference									
Defrost system	Distributed reverse cycle system				Distributed reverse cycle system					
Protective device	High-pressure switch, Over current protection, Inverter overload protection (compressor, fan, pump), Crankcase heater, Open-phase protection, Microprocessor control (compressor time guards, freeze protection, high water temp. cutout, low flow rate, discharge gas overheat protection, low pressure cutout, thermistor error, high water pressure error)									
Piping diameter Sound level (Note 13)	Cold/Hot water inlet (A)	65 flange x 1 (JIS10K)				65 flange x 1 (JIS10K)				
	Cold/Hot water outlet (A)	65 flange x 1 (JIS10K)				65 flange x 1 (JIS10K)				
	Coil drain (A)	PT40 screw x 1				PT40 screw x 1				
	Control box side (dBA)	72.9				72.9				
Coil side (dBA)	74.0				74.0					
Water piping side (dBA)	70.2				70.2					
Required products sold separately	Module controller (MC) (include external sensor x 2) (Note 14)									

(Note 1) Rated conditions, such as capacity, electrical data, and standard flow rate are as follows.
 For cooling : 14°C entering water (EWT), 7°C leaving water (LWT), 35°C DB/24°C WD outdoor air (OAT) and 21°C feed-water temperature
 For heating : 38°C entering water (EWT), 45°C leaving water (LWT), 7°C DB/6°C WD outdoor air (OAT)
 Numbers in parenthesis indicate values for a difference of 5°C.
 For cooling : 12°C entering water (EWT), 7°C leaving water (LWT)
 For heating : 38°C entering water (EWT), 45°C leaving water (LWT)
 Same capacities, outdoor air temperature, and supplied water temperature (only for High EER type) as indicated above.
 Design water flow rate must be within the range of 5 to 10°C water temperature differences. Capacities and performance values are based on AHRIS50-590.

(Note 2) Dimensions do not include projections of water pipe connections.
 (Note 3) Even when there is a fluctuation in supply voltage, do not exceed ±10% and keep imbalances between the supply voltages within 2%.
 (Note 4) Output of the integrated pump can change depending on the outlet pump head required to comply with the indent. The power supply design at that time differs from those of a standard pump.
 (Note 5) Always install an earth leakage circuit breaker. This machine includes an inverter, so please use a high-frequency-compatible product to prevent malfunction.
 (Note 6) Note that electrical data do not include internal pump.
 (Note 7) Power factors may vary depending on site conditions.
 (Note 8) The indicated value for IPLV (Integrated Part Load Value, cooling) is based on the AHRIS50-590 "Water Chilling Unit".
 (Note 9) The supply water quality may cause scales and other matter to adhere to the coil surface. If necessary, install a water softener on the supply water side. (Provided locally)
 (Note 10) Adjust the flow rate to become close to this supply water pressure with the manual flow adjustment valve on the water spray system inlet. If sufficient supply water pressure is not available, install a pressure pump. (Provided locally)
 (Note 11) Working pressure : below 0.7 MPa.
 (Note 12) Range of capacity control sometimes can vary depending on the unit's operating condition.
 (Note 13) (Measurement position: Distance of 1.0m, height of 1.5m) The on-site sound level will be higher due to the affection of back noise and sound reflection.
 (Note 14) The external sensor's lead wire length is 30 m.

70HP model

Cooling-only

	Standard type				High-EER type					
	380V 70HP	400V 70HP	415V 70HP	440V 70HP	380V 70HP	400V 70HP	415V 70HP	440V 70HP		
Model (A single module unit)	RUA-UP5611-S	RUA-UP5612-S	RUA-UP5613-S	RUA-UP5614-S	RUA-UP561N1-S	RUA-UP561N2-S	RUA-UP561N3-S	RUA-UP561N4-S		
Cooling capacity (Note 1) (kW)	200				200					
Exterior	Unit color: Silky shade (Munsell 1Y8.5/0.5)									
	Dimensions	Height (mm)	2,350			2,350				
		Width (Note 2) (mm)	1,000			1,000				
	Depth (Note 2) (mm)	3,300			3,300					
Shipping weight (kg)	1,295				1,307					
Operating weight (kg)	1,331				1,343					
Power supply (Note 1-3)	3-phase 3-wire 50/60Hz 380V/400V/415V, 3-phase 3-wire 60Hz 440V				3-phase 3-wire 50/60Hz 380V/400V/415V, 3-phase 3-wire 60Hz 440V					
Reference current for power supply design (Note 4-5) (A)	118				118					
Electrical data (Note 1-6)	Cooling	Nominal current (A)	109 (111)	103 (106)	99.3 (102)	93.7 (96.0)	72.0 (74.5)	68.4 (70.8)	66.0 (68.2)	62.2 (64.3)
		Nominal input (kW)	70.7 (72.5)				46.9 (48.5)			
		EER	2.83 (2.76)				4.26 (4.12)			
		Power factor (Note 7) (%)	99				99			
IPLV (With a 5°C difference) (Note 8)	6.0				6.1					
Compressor	Type	Hermetic rotary x 4				Hermetic rotary x 4				
	Model name	RA1000A4F-11UC				RA1000A4F-11UC				
	Motor output x number of units (kW)	15.4 x 4				10.7 x 4				
	Type of start	Inverter starter				Inverter starter				
	Case heater (W)	37 x 4				37 x 4				
Compressor oil	Type	RB74AF				RB74AF				
	Charge (L)	2.0 x 4				2.0 x 4				
Condenser coil - air side	Plate fin coil				Plate fin coil					
Fan	Type	Propeller fan				Propeller fan				
	Air quantity (m ³ /min)	1,230 (maximum)				1,230 (maximum)				
	Type of start	Inverter starter				Inverter starter				
Water spray system (Note 9)	Motor output x number of units (kW)	1.2 x 4				1.2 x 4				
	Water spray volume (L/min)	—				13.6 x 1				
	Supply water pressure (Note 10) (MPa)	—				0.2				
	Control	—				Continuous water spraying when outside temperature exceeds setting and compressor capacity exceeds setting				
Pumps (Note 4)	Motor output (kW)	2.2				2.2				
	Type	Centrifugal pump				Centrifugal pump				
	Flow control	Inverter				Inverter				
	Maximum current (A)	3.1				3.1				
Maximum input (kW)	2.0				2.0					
Cooler - water side (Note 11)	Braze plate heat exchanger (SUS316 equivalent)				Braze plate heat exchanger (SUS316 equivalent)					
Refrigerant	Type	R410A				R410A				
	R410 charge (kg)	10.2 x 4				10.2 x 4				
	Control	Electric expansion valve				Electric expansion valve				
Capacity control steps (Note 12) (%)	0.5 ~ 100				0.5 ~ 100					
Operation control	Microprocessor control based on leaving water temperature and temperature difference									
Protective device	High-pressure switch, Over current protection, Inverter overload protection (compressor, fan, pump), Crankcase heater, Open-phase protection, Microprocessor control (compressor time guards, freeze protection, low flow rate, discharge gas overheat protection, low pressure cutout, thermistor error, high water pressure error)									
Piping dimensions	Cold/Hot water inlet (A)	80 flange x 1 (JIS10K)				80 flange x 1 (JIS10K)				
	Cold/Hot water outlet (A)	80 flange x 1 (JIS10K)				80 flange x 1 (JIS10K)				
	Coil drain (A)	PT40 screw x 1				PT40 screw x 1				
Sound level (Note 13)	Control box side (dBA)	72.9				72.9				
	Coil side (dBA)	74.6				74.6				
	Water piping side (dBA)	68.6				68.6				
Required products sold separately	Module controller (MC) (include external sensor x 2) (Note 14)									

(Note 1) Rated conditions, such as capacity, electrical data, and standard flow rate are as follows.
 For cooling : 14°C entering water (EWT), 7°C leaving water (LWT), 35°CDB/24°CWD outdoor air (OAT) and 21°C feed-water temperature
 For heating : 38°C entering water (EWT), 45°C leaving water (LWT), 7°CDB/6°CWD outdoor air (OAT)
 Numbers in parenthesis indicate values for a difference of 5°C.
 For cooling: 12°C entering water (EWT), 7°C leaving water (LWT)
 For heating: 38°C entering water (EWT), 45°C leaving water (LWT)
 Same capacities, outdoor air temperature, and supplied water temperature (only for High EER type) as indicated above.
 Design water flow rate must be within the range of 5 to 10°C water temperature differences. Capacities and performance values are based on AHRI550-590.

(Note 2) Dimensions do not include projections of water pipe connections.

(Note 3) Even when there is a fluctuation in supply voltage, do not exceed ± 10% and keep imbalances between the supply voltages within 2%.

(Note 4) Output of the integrated pump can change depending on the outlet pump head required to comply with the indent. The power supply design at that time differs from those of a standard pump.

(Note 5) Always install an earth leakage circuit breaker. This machine includes an inverter, so please use a high-frequency-compatible product to prevent malfunction.

(Note 6) Note that electrical data do not include internal pump.

(Note 7) Power factors may vary depending on site conditions.

(Note 8) The indicated value for IPLV (Integrated Part Load Value, cooling) is based on the AHRI550-590 "Water Chilling Unit".

(Note 9) The supply water quality may cause scales and other matter to adhere to the coil surface. If necessary, install a water softener on the supply water side. (Provided locally)

(Note 10) Adjust the flow rate to become close to this supply water pressure with the manual flow adjustment valve on the water spray system inlet. If sufficient supply water pressure is not available, install a pressure pump. (Provided locally)

(Note 11) Working pressure : below 0.7 MPa.

(Note 12) Range of capacity control sometimes can vary depending on the unit's operating condition.

(Note 13) (Measurement position: Distance of 1.0m, height of 1.5m) The on-site sound level will be higher due to the affection of back noise and sound reflection.

(Note 14) The external sensor's lead wire length is 30 m.

Specifications Internal inverter pump

70HP model

Heat pump

	Standard type				High-EER type					
	380V 70HP	400V 70HP	415V 70HP	440V 70HP	380V 70HP	400V 70HP	415V 70HP	440V 70HP		
Model (A single module unit)	RUA-UP561H1-S	RUA-UP561H2-S	RUA-UP561H3-S	RUA-UP561H4-S	RUA-UP561HN1-S	RUA-UP561HN2-S	RUA-UP561HN3-S	RUA-UP561HN4-S		
Cooling capacity (Note 1) (kW)	200				200					
Heating capacity (Note 1) (kW)	200				200					
Exterior	Unit color	Silky shade (Munsell 1Y8.5/0.5)				Silky shade (Munsell 1Y8.5/0.5)				
	Dimensions	Height (mm)	2,350				2,350			
		Width (Note 2) (mm)	1,000				1,000			
		Depth (Note 2) (mm)	3,300				3,300			
Shipping weight (kg)	1,332				1,344					
Operating weight (kg)	1,368				1,380					
Power supply (Note 1-3)	3-phase 3-wire 50/60Hz 380V/400V/415V, 3-phase 3-wire 60Hz 440V				3-phase 3-wire 50/60Hz 380V/400V/415V, 3-phase 3-wire 60Hz 440V					
Reference current for power supply design (Note 4-5) (A)	118				118					
Electrical data (Note 6)	Cooling	Nominal current (A)	109 (111)	103 (106)	99.3 (102)	93.7 (96.0)	72.0 (74.5)	68.4 (70.8)	66.0 (68.2)	62.2 (64.3)
		Nominal input (kW)	70.7 (72.5)				46.9 (48.5)			
		EER	2.83 (2.76)				4.26 (4.12)			
		Power factor (Note 7) (%)	99				99			
	Heating	Nominal current (A)	95.9 (97.1)	91.1 (92.3)	87.8 (88.8)	82.8 (83.9)	95.9 (97.1)	91.1 (92.3)	87.8 (88.9)	82.8 (83.9)
		Nominal input (kW)	62.5 (63.3)				62.5 (63.3)			
		COP	3.20 (3.16)				3.20 (3.16)			
		Power factor (Note 7) (%)	99				99			
IPLV (With a 5°C difference) (Note 8)	6.0				6.1					
Compressor	Type	Hermetic rotary x 4				Hermetic rotary x 4				
	Model name	RA1000A4F-11UC				RA1000A4F-11UC				
	Motor output x number of units (kW)	15.4 x 4				13.5 x 4				
	Type of start	Inverter starter				Inverter starter				
	Case heater (W)	37 x 4				37 x 4				
Compressor oil	Type	RB74AF				RB74AF				
	Charge (L)	2.0 x 4				2.0 x 4				
Condenser coil - air side	Plate fin coil				Plate fin coil					
Fan	Type	Propeller fan				Propeller fan				
	Air quantity (m ³ /min)	1,230 (maximum)				1,230 (maximum)				
	Type of start	Inverter starter				Inverter starter				
	Motor output x number of units (kW)	1.2 x 4				1.2 x 4				
Water spray system (Note 9)	Water spray volume (L/min)	—				13.6 x 1				
	Supply water pressure (Note 10) (MPa)	—				0.2				
	Control	—				Continuous water spraying when outside temperature exceeds setting and compressor capacity exceeds setting				
Pump (Note 4)	Motor output (kW)	2.2				2.2				
	Type	Centrifugal pump				Centrifugal pump				
	Flow control	Inverter				Inverter				
	Maximum current (A)	3.1				3.1				
Maximum input (kW)	2.0				2.0					
Cooler - water side (Note 11)	Braze plate heat exchanger (SUS316 equivalent)				Braze plate heat exchanger (SUS316 equivalent)					
Refrigerant	Type	R410A				R410A				
	R410 charge (kg)	10.6 x 4				10.6 x 4				
	Control	Electric expansion valve				Electric expansion valve				
Capacity control steps (Note 12) (%)	0.5 ~ 100				0.5 ~ 100					
Operation control	Microprocessor control based on leaving water temperature and temperature difference									
Defrost system	Distributed reverse cycle system				Distributed reverse cycle system					
Protective device	High-pressure switch, Over current protection, Inverter overload protection (compressor, fan, pump), Crankcase heater, Open-phase protection, Microprocessor control (compressor time guards, freeze protection, high water temp. cutout, low flow rate, discharge gas overheat protection, low pressure cutout, thermistor error, high water pressure error)									
Piping/anchors	Cold/Hot water inlet (A)	80 flange x 1 (JIS10K)				80 flange x 1 (JIS10K)				
	Cold/Hot water outlet (A)	80 flange x 1 (JIS10K)				80 flange x 1 (JIS10K)				
	Coil drain (A)	PT40 screw x 1				PT40 screw x 1				
Sound level (Note 13)	Control box side (dBA)	72.9				72.9				
	Coil side (dBA)	74.6				74.6				
	Water piping side (dBA)	68.6				68.6				
Required products sold separately	Module controller (MC) (include external sensor x 2) (Note 14)									

(Note 1) Rated conditions, such as capacity, electrical data, and standard flow rate are as follows.
 For cooling : 14°C entering water (EWT), 7°C leaving water (LWT), 35°CDB/24°CWD outdoor air (OAT) and 21°C feed-water temperature
 For heating : 38°C entering water (EWT), 45°C leaving water (LWT), 7°CDB/6°CWD outdoor air (OAT)
 Numbers in parenthesis indicate values for a difference of 5°C.
 For cooling : 12°C entering water (EWT), 7°C leaving water (LWT)
 For heating : 38°C entering water (EWT), 45°C leaving water (LWT)
 Same capacities, outdoor air temperature, and supplied water temperature (only for High EER type) as indicated above.
 Design water flow rate must be within the range of 5 to 10°C water temperature differences. Capacities and performance values are based on AHRI550-590.

(Note 2) Dimensions do not include projections of water pipe connections.
 (Note 3) Even when there is a fluctuation in supply voltage, do not exceed ±10% and keep imbalances between the supply voltages within 2%.
 (Note 4) Output of the integrated pump can change depending on the outlet pump head required to comply with the indent. The power supply design at that time differs from those of a standard pump.
 (Note 5) Always install an earth leakage circuit breaker. This machine includes an inverter, so please use a high-frequency-compatible product to prevent malfunction.
 (Note 6) Note that electrical data do not include internal pump.
 (Note 7) Power factors may vary depending on site conditions.
 (Note 8) The indicated value for IPLV (Integrated Part Load Value, cooling) is based on the AHRI550-590 "Water Chilling Unit".
 (Note 9) The supply water quality may cause scales and other matter to adhere to the coil surface. If necessary, install a water softener on the supply water side. (Provided locally)
 (Note 10) Adjust the flow rate to become close to this supply water pressure with the manual flow adjustment valve on the water spray system inlet. If sufficient supply water pressure is not available, install a pressure pump.(Provided locally)
 (Note 11) Working pressure : below 0.7 MPa.
 (Note 12) Range of capacity control sometimes can vary depending on the unit's operating condition.
 (Note 13) (Measurement position: Distance of 1.0m, height of 1.5m) The on-site sound level will be higher due to the affection of back noise and sound reflection.
 (Note 14) The external sensor's lead wire length is 30 m.

60HP model

Cooling-only

	Standard type				High-EER type					
	380V 60HP	400V 60HP	415V 60HP	440V 60HP	380V 60HP	400V 60HP	415V 60HP	440V 60HP		
Model (A single module unit)	RUA-UP511L1-S	RUA-UP511L2-S	RUA-UP511L3-S	RUA-UP511L4-S	RUA-UP511LN1-S	RUA-UP511LN2-S	RUA-UP511LN3-S	RUA-UP511LN4-S		
Cooling capacity (Note 1) (kW)	180				180					
Exterior	Unit color Silky shade (Munsell 1Y8.5/0.5)									
	Dimensions	Height (mm)	2,350			2,350				
		Width (Note 2) (mm)	1,000			1,000				
		Depth (Note 2) (mm)	3,300			3,300				
Shipping weight (kg)	1,229				1,241					
Operating weight (kg)	1,265				1,277					
Power supply (Note 1-3)	3-phase 3-wire 50/60Hz 380V/400V/415V, 3-phase 3-wire 60Hz 440V				3-phase 3-wire 50/60Hz 380V/400V/415V, 3-phase 3-wire 60Hz 440V					
Reference current for power supply design (Note 4) (A)	95				95					
Electrical data (Note 1)	Cooling	Nominal current (A)	86.9 (89.1)	82.5 (84.7)	79.5 (81.6)	75.0 (77.0)	58.5 (60.6)	55.6 (57.6)	53.6 (55.5)	50.5 (52.3)
		Nominal input (kW)	56.6 (58.1)				38.1 (39.5)			
		EER	3.18 (3.10)				4.72 (4.56)			
		Power factor (Note 5) (%)	99				99			
IPLV (With a 5°C difference) (Note 6)	6.4				6.4					
Compressor	Type	Hermetic rotary x 4				Hermetic rotary x 4				
	Model name	RA1000A4F-11UC				RA1000A4F-11UC				
	Motor output x number of units (kW)	12.4 x 4				8.2 x 4				
	Type of start	Inverter starter				Inverter starter				
	Case heater (W)	37 x 4				37 x 4				
Compressor oil	Type	RB74AF				RB74AF				
	Charge (L)	2.0 x 4				2.0 x 4				
Condenser coil - air side	Plate fin coil				Plate fin coil					
Fan	Type	Propeller fan				Propeller fan				
	Air quantity (m ³ /min)	1,230 (maximum)				1,230 (maximum)				
	Type of start	Inverter starter				Inverter starter				
	Motor output x number of units (kW)	1.2 x 4				1.2 x 4				
Water spray system (Note 7)	Water spray volume (L/min)	—				13.6 x 1				
	Supply water pressure (Note 8) (MPa)	—				0.2				
	Control	—				Continuous water spraying when outside temperature exceeds setting and compressor capacity exceeds setting				
Cooler - water side (Note 9)	Braze plate heat exchanger (SUS316 equivalent)				Braze plate heat exchanger (SUS316 equivalent)					
Refrigerant	Type	R410A				R410A				
	R410 charge (kg)	10.2 x 4				10.2 x 4				
	Control	Electric expansion valve				Electric expansion valve				
Capacity control steps (Note 10) (%)	0.5 ~ 100				0.5 ~ 100					
Operation control	Microprocessor control based on leaving water temperature and temperature difference									
Protective device	High-pressure switch, Over current protection, Inverter overload protection (compressor, fan, pump), Crankcase heater, Open-phase protection, Microprocessor control (compressor time guards, freeze protection, low flow rate, discharge gas overheat protection, low pressure cutout, thermistor error, high water pressure error)									
Piping diameters	Cold/Hot water inlet (A)	65 flange x 1 (JIS10K)				65 flange x 1 (JIS10K)				
	Cold/Hot water outlet (A)	65 flange x 1 (JIS10K)				65 flange x 1 (JIS10K)				
	Coil drain (A)	PT40 screw x 1				PT40 screw x 1				
Sound level (Note 11)	Control box side (dBA)	72.9				72.9				
	Coil side (dBA)	74.0				74.0				
	Water piping side (dBA)	70.2				70.2				
Required products sold separately	Module controller (MC)									

(Note 1) Rated conditions, such as capacity, electrical data, and standard flow rate are as follows.
 For cooling : 14°C entering water (EWT), 7°C leaving water (LWT), 35°C DB/24°C WD outdoor air (OAT) and 21°C feed-water temperature
 For heating : 38°C entering water (EWT), 45°C leaving water (LWT), 7°C DB/6°C WD outdoor air (OAT)
 Numbers in parenthesis indicate values for a difference of 5°C.
 For cooling: 12°C entering water (EWT), 7°C leaving water (LWT)
 For heating: 38°C entering water (EWT), 45°C leaving water (LWT)
 Same capacities, outdoor air temperature, and supplied water temperature (only for High EER type) as indicated above.
 Design water flow rate must be within the range of 5 to 10°C water temperature differences. Capacities and performance values are based on AHRI550-590.

(Note 2) Dimensions do not include projections of water pipe connections.

(Note 3) Even when there is a fluctuation in supply voltage, do not exceed ±10% and keep imbalances between the supply voltages within 2%.

(Note 4) Always install an earth leakage circuit breaker. This machine includes an inverter, so please use a high-frequency-compatible product to prevent malfunction.

(Note 5) Power factors may vary depending on site conditions.

(Note 6) The indicated value for IPLV (Integrated Part Load Value, cooling) is based on the AHRI550-590 "Water Chilling Unit".

(Note 7) The supply water quality may cause scales and other matter to adhere to the coil surface. If necessary, install a water softener on the supply water side. (Provided locally)

(Note 8) Adjust the flow rate to become close to this supply water pressure with the manual flow adjustment valve on the water spray system inlet. If sufficient supply water pressure is not available, install a pressure pump. (Provided locally)

(Note 9) Working pressure : below 0.98 MPa.

(Note 10) Range of capacity control sometimes can vary depending on the unit's operating condition.

(Note 11) (Measurement position: Distance of 1.0m, height of 1.5m) The on-site sound level will be higher due to the affection of back noise and sound reflection.

Specifications **Pumpless**

60HP model

Heat pump

	Standard type				High-EER type					
	380V	400V	415V	440V	380V	400V	415V	440V		
	60HP	60HP	60HP	60HP	60HP	60HP	60HP	60HP		
Model (A single module unit)	RUA-UP511HL1-S	RUA-UP511HL2-S	RUA-UP511HL3-S	RUA-UP511HL4-S	RUA-UP511HLN1-S	RUA-UP511HLN2-S	RUA-UP511HLN3-S	RUA-UP511HLN4-S		
Cooling capacity (Note 1) (kW)	180				180					
Heating capacity (Note 1) (kW)	180				180					
Exterior	Unit color: Silky shade (Munsell 1Y8.5/0.5)									
	Dimensions	Height (mm)	2,350			2,350				
		Width (Note 2) (mm)	1,000			1,000				
		Depth (Note 2) (mm)	3,300			3,300				
Shipping weight (kg)	1,265				1,278					
Operating weight (kg)	1,301				1,314					
Power supply (Note 1-3)	3-phase 3-wire 50/60Hz 380V/400V/415V, 3-phase 3-wire 60Hz 440V				3-phase 3-wire 50/60Hz 380V/400V/415V, 3-phase 3-wire 60Hz 440V					
Reference current for power supply design (Note 4) (A)	95				95					
Electrical data (Note 1)	Cooling	Nominal current (A)	86.9 (89.1)	82.5 (84.7)	79.5 (81.6)	75.0 (77.0)	58.5 (60.6)	55.6 (57.6)	53.6 (55.5)	50.5 (52.3)
		Nominal input (kW)	56.6 (58.1)				38.1 (39.5)			
		EER	3.18 (3.10)				4.72 (4.56)			
		Power factor (Note 5) (%)	99				99			
	Heating	Nominal current (A)	82.4 (83.5)	78.3 (79.3)	75.5 (76.4)	71.2 (72.1)	82.4 (83.5)	78.3 (79.3)	75.5 (76.4)	71.2 (72.1)
		Nominal input (kW)	53.7 (54.4)				53.7 (54.4)			
		COP	3.35 (3.31)				3.35 (3.31)			
		Power factor (Note 5) (%)	99				99			
IPLV (With a 5°C difference) (Note 8)	6.4				6.4					
Compressor	Type	Hermetic rotary x 4				Hermetic rotary x 4				
	Model name	RA1000A4F-11UC				RA1000A4F-11UC				
	Motor output x number of units (kW)	12.4 x 4				11.9 x 4				
	Type of start	Inverter starter				Inverter starter				
	Case heater (W)	37 x 4				37 x 4				
Compressor oil	Type	RB74AF				RB74AF				
	Charge (L)	2.0 x 4				2.0 x 4				
Condenser coil - air side	Plate fin coil				Plate fin coil					
Fan	Type	Propeller fan				Propeller fan				
	Air quantity (m ³ /min)	1,230 (maximum)				1,230 (maximum)				
	Type of start	Inverter starter				Inverter starter				
	Motor output x number of units (kW)	1.2 x 4				1.2 x 4				
Water spray system (Note 7)	Water spray volume (L/min)	—				13.6 x 1				
	Supply water pressure (Note 8) (MPa)	—				0.2				
	Control	—				Continuous water spraying when outside temperature exceeds setting and compressor capacity exceeds setting				
Cooler - water side (Note 9)	Braze plate heat exchanger (SUS316 equivalent)				Braze plate heat exchanger (SUS316 equivalent)					
Refrigerant	Type	R410A				R410A				
	R410 charge (kg)	10.6 x 4				10.6 x 4				
	Control	Electric expansion valve				Electric expansion valve				
Capacity control steps (Note 10) (%)	0.5 ~ 100				0.5 ~ 100					
Operation control	Microprocessor control based on leaving water temperature and temperature difference									
Defrost system	Distributed reverse cycle system				Distributed reverse cycle system					
Protective device	High-pressure switch, Over current protection, Inverter overload protection (compressor, fan, pump), Crankcase heater, Open-phase protection, Microprocessor control (compressor time guards, freeze protection, high water temp. cutout, low flow rate, discharge gas overheat protection, low pressure cutout, thermistor error, high water pressure error)									
Piping diameters	Cold/Hot water inlet (A)	65 flange x 1 (JIS10K)				65 flange x 1 (JIS10K)				
	Cold/Hot water outlet (A)	65 flange x 1 (JIS10K)				65 flange x 1 (JIS10K)				
	Coil drain (A)	PT40 screw x 1				PT40 screw x 1				
Sound level (Note 11)	Control box side (dBA)	72.9				72.9				
	Coil side (dBA)	74.0				74.0				
	Water piping side (dBA)	70.2				70.2				
Required products sold separately	Module controller (MC)									

(Note 1) Rated conditions, such as capacity, electrical data, and standard flow rate are as follows.
 For cooling : 14°C entering water (EWT), 7°C leaving water (LWT), 35°C DB/24°C WDW outdoor air (OAT) and 21°C feed-water temperature
 For heating : 38°C entering water (EWT), 45°C leaving water (LWT), 7°C DB/6°C WDW outdoor air (OAT)
 Numbers in parenthesis indicate values for a difference of 5°C.
 For cooling: 12°C entering water (EWT), 7°C leaving water (LWT)
 For heating: 38°C entering water (EWT), 45°C leaving water (LWT)
 Same capacities, outdoor air temperature, and supplied water temperature (only for High EER type) as indicated above.
 Design water flow rate must be within the range of 5 to 10°C water temperature differences. Capacities and performance values are based on AHRI550-590.

(Note 2) Dimensions do not include projections of water pipe connections.
 (Note 3) Even when there is a fluctuation in supply voltage, do not exceed ±10% and keep imbalances between the supply voltages within 2%.
 (Note 4) Always install an earth leakage circuit breaker. This machine includes an inverter, so please use a high-frequency-compatible product to prevent malfunction.
 (Note 5) Power factors may vary depending on site conditions.
 (Note 6) The indicated value for IPLV (Integrated Part Load Value, cooling) is based on the AHRI550-590 "Water Chilling Unit".
 (Note 7) The supply water quality may cause scales and other matter to adhere to the coil surface. If necessary, install a water softener on the supply water side. (Provided locally)
 (Note 8) Adjust the flow rate to become close to this supply water pressure with the manual flow adjustment valve on the water spray system inlet. If sufficient supply water pressure is not available, install a pressure pump. (Provided locally)
 (Note 9) Working pressure : below 0.98 MPa.
 (Note 10) Range of capacity control sometimes can vary depending on the unit's operating condition.
 (Note 11) (Measurement position: Distance of 1.0m, height of 1.5m) The on-site sound level will be higher due to the affection of back noise and sound reflection.

70HP model

Cooling-only

	Standard type				High-EER type					
	380V 70HP	400V 70HP	415V 70HP	440V 70HP	380V 70HP	400V 70HP	415V 70HP	440V 70HP		
Model (A single module unit)	RUA-UP561L1-S	RUA-UP561L2-S	RUA-UP561L3-S	RUA-UP561L4-S	RUA-UP561LN1-S	RUA-UP561LN2-S	RUA-UP561LN3-S	RUA-UP561LN4-S		
Cooling capacity (Note 1) (kW)	200				200					
Exterior	Unit color Silky shade (Munsell 1Y8.5/0.5)									
	Dimensions	Height (mm)	2,350			2,350				
		Width (Note 2) (mm)	1,000			1,000				
		Depth (Note 2) (mm)	3,300			3,300				
Shipping weight (kg)	1,235				1,247					
Operating weight (kg)	1,271				1,283					
Power supply (Note 1-3)	3-phase 3-wire 50/60Hz 380V/400V/415V, 3-phase 3-wire 60Hz 440V				3-phase 3-wire 50/60Hz 380V/400V/415V, 3-phase 3-wire 60Hz 440V					
Reference current for power supply design (Note 4) (A)	114				114					
Electrical data (Note 1)	Cooling	Nominal current (A)	109 (111)	103 (106)	99.3 (102)	93.7 (96.0)	72.0 (74.5)	68.4 (70.8)	66.0 (68.2)	62.2 (64.3)
		Nominal input (kW)	70.7 (72.5)				46.9 (48.5)			
		EER	2.83 (2.76)				4.26 (4.12)			
		Power factor (Note 5) (%)	99				99			
IPLV (With a 5°C difference) (Note 6)	6.0				6.1					
Compressor	Type	Hermetic rotary x 4				Hermetic rotary x 4				
	Model name	RA1000A4F-11UC				RA1000A4F-11UC				
	Motor output x number of units (kW)	15.4 x 4				10.7 x 4				
	Type of start	Inverter starter				Inverter starter				
	Case heater (W)	37 x 4				37 x 4				
Compressor oil	Type	RB74AF				RB74AF				
	Charge (L)	2.0 x 4				2.0 x 4				
Condenser coil - air side	Plate fin coil				Plate fin coil					
Fan	Type	Propeller fan				Propeller fan				
	Air quantity (m ³ /min)	1,230 (maximum)				1,230 (maximum)				
	Type of start	Inverter starter				Inverter starter				
	Motor output x number of units (kW)	1.2 x 4				1.2 x 4				
Water spray system (Note 7)	Water spray volume (L/min)	—				13.6 x 1				
	Supply water pressure (Note 8) (MPa)	—				0.2				
	Control	—				Continuous water spraying when outside temperature exceeds setting and compressor capacity exceeds setting				
Cooler - water side (Note 9)	Braze plate heat exchanger (SUS316 equivalent)				Braze plate heat exchanger (SUS316 equivalent)					
Refrigerant	Type	R410A				R410A				
	R410 charge (kg)	10.2 x 4				10.2 x 4				
	Control	Electric expansion valve				Electric expansion valve				
Capacity control steps (Note 10) (%)	0.5 ~ 100				0.5 ~ 100					
Operation control	Microprocessor control based on leaving water temperature and temperature difference									
Protective device	High-pressure switch, Over current protection, Inverter overload protection (compressor, fan, pump), Crankcase heater, Open-phase protection, Microprocessor control (compressor time guards, freeze protection, low flow rate, discharge gas overheat protection, low pressure cutout, thermistor error, high water pressure error)									
Piping diameters	Cold/Hot water inlet (A)	80 flange x 1 (JIS10K)				80 flange x 1 (JIS10K)				
	Cold/Hot water outlet (A)	80 flange x 1 (JIS10K)				80 flange x 1 (JIS10K)				
	Coil drain (A)	PT40 screw x 1				PT40 screw x 1				
Sound level (Note 11)	Control box side (dBA)	72.9				72.9				
	Coil side (dBA)	74.6				74.6				
	Water piping side (dBA)	68.6				68.6				
Required products sold separately	Module controller (MC)									

(Note 1) Rated conditions, such as capacity, electrical data, and standard flow rate are as follows.
 For cooling : 14°C entering water (EWT), 7°C leaving water (LWT), 35°CDB/24°CWD outdoor air (OAT) and 21°C feed-water temperature
 For heating : 38°C entering water (EWT), 45°C leaving water (LWT), 7°CDB/6°CWD outdoor air (OAT)
 Numbers in parenthesis indicate values for a difference of 5°C.
 For cooling: 12°C entering water (EWT), 7°C leaving water (LWT)
 For heating: 38°C entering water (EWT), 45°C leaving water (LWT)
 Same capacities, outdoor air temperature, and supplied water temperature (only for High EER type) as indicated above.
 Design water flow rate must be within the range of 5 to 10°C water temperature differences. Capacities and performance values are based on AHRI550-590.

(Note 2) Dimensions do not include projections of water pipe connections.
 (Note 3) Even when there is a fluctuation in supply voltage, do not exceed ±10% and keep imbalances between the supply voltages within 2%.
 (Note 4) Always install an earth leakage circuit breaker. This machine includes an inverter, so please use a high-frequency-compatible product to prevent malfunction.
 (Note 5) Power factors may vary depending on site conditions.
 (Note 6) The indicated value for IPLV (Integrated Part Load Value, cooling) is based on the AHRI550-590 "Water Chilling Unit".
 (Note 7) The supply water quality may cause scales and other matter to adhere to the coil surface. If necessary, install a water softener on the supply water side. (Provided locally)
 (Note 8) Adjust the flow rate to become close to this supply water pressure with the manual flow adjustment valve on the water spray system inlet. If sufficient supply water pressure is not available, install a pressure pump. (Provided locally)
 (Note 9) Working pressure : below 0.98 MPa.
 (Note 10) Range of capacity control sometimes can vary depending on the unit's operating condition.
 (Note 11) (Measurement position: Distance of 1.0m, height of 1.5m) The on-site sound level will be higher due to the affection of back noise and sound reflection.

Specifications **Pumpless**

70HP model

Heat pump

	Standard type				High-EER type					
	380V	400V	415V	440V	380V	400V	415V	440V		
	70HP	70HP	70HP	70HP	70HP	70HP	70HP	70HP		
Model (A single module unit)	RUA-UP561HL1-S	RUA-UP561HL2-S	RUA-UP561HL3-S	RUA-UP561HL4-S	RUA-UP561HLN1-S	RUA-UP561HLN2-S	RUA-UP561HLN3-S	RUA-UP561HLN4-S		
Cooling capacity (Note 1) (kW)	200				200					
Heating capacity (Note 1) (kW)	200				200					
Exterior	Unit color	Silky shade (Munsell 1Y8.5/0.5)				Silky shade (Munsell 1Y8.5/0.5)				
	Dimensions	Height (mm)	2,350				2,350			
		Width (Note 2) (mm)	1,000				1,000			
		Depth (Note 2) (mm)	3,300				3,300			
Shipping weight (kg)	1,271				1,284					
Operating weight (kg)	1,307				1,320					
Power supply (Note 1-3)	3-phase 3-wire 50/60Hz 380V/400V/415V, 3-phase 3-wire 60Hz 440V				3-phase 3-wire 50/60Hz 380V/400V/415V, 3-phase 3-wire 60Hz 440V					
Reference current for power supply design (Note 4) (A)	114				114					
Electrical data (Note 1)	Cooling	Nominal current (A)	109 (111)	103 (106)	99.3 (102)	93.7 (96.0)	72.0 (74.5)	68.4 (70.8)	66.0 (68.2)	62.2 (64.3)
		Nominal input (kW)	70.7 (72.5)				46.9 (48.5)			
		EER	2.83 (2.76)				4.26 (4.12)			
		Power factor (Note 5) (%)	99				99			
	Heating	Nominal current (A)	95.9 (97.1)	91.1 (92.3)	87.8 (88.9)	82.8 (83.9)	95.9 (97.1)	91.1 (92.3)	87.8 (88.9)	82.8 (83.9)
		Nominal input (kW)	62.5 (63.3)				62.5 (63.3)			
		COP	3.20 (3.16)				3.20 (3.16)			
		Power factor (Note 5) (%)	99				99			
IPLV (With a 5°C difference) (Note 6)	6.0				6.1					
Compressor	Type	Hermetic rotary x 4				Hermetic rotary x 4				
	Model name	RA1000A4F-11UC				RA1000A4F-11UC				
	Motor output x number of units (kW)	15.4 x 4				15.4 x 4				
	Type of start	Inverter starter				Inverter starter				
	Case heater (W)	37 x 4				37 x 4				
Compressor oil	Type	RB74AF				RB74AF				
	Charge (L)	2.0 x 4				2.0 x 4				
Condenser coil - air side	Plate fin coil				Plate fin coil					
Fan	Type	Propeller fan				Propeller fan				
	Air quantity (m ³ /min)	1,230 (maximum)				1,230 (maximum)				
	Type of start	Inverter starter				Inverter starter				
	Motor output x number of units (kW)	1.2 x 4				1.2 x 4				
Water spray system (Note 7)	Water spray volume (L/min)	—				13.6 x 1				
	Supply water pressure (Note 8) (MPa)	—				0.2				
	Control	—				Continuous water spraying when outside temperature exceeds setting and compressor capacity exceeds setting				
Cooler - water side (Note 9)	Braze plate heat exchanger (SUS316 equivalent)				Braze plate heat exchanger (SUS316 equivalent)					
Refrigerant	Type	R410A				R410A				
	R410 charge (kg)	10.6 x 4				10.6 x 4				
	Control	Electric expansion valve				Electric expansion valve				
Capacity control steps (Note 10) (%)	0.5 ~ 100				0.5 ~ 100					
Operation control	Microprocessor control based on leaving water temperature and temperature difference									
Defrost system	Distributed reverse cycle system				Distributed reverse cycle system					
Protective device	High-pressure switch, Over current protection, Inverter overload protection (compressor, fan, pump), Crankcase heater, Open-phase protection, Microprocessor control (compressor time guards, freeze protection, high water temp. cutout, low flow rate, discharge gas overheat protection, low pressure cutout, thermistor error, high water pressure error)									
Piping diameters (mm)	Cold/Hot water inlet (A)	80 flange x 1 (JIS10K)				80 flange x 1 (JIS10K)				
	Cold/Hot water outlet (A)	80 flange x 1 (JIS10K)				80 flange x 1 (JIS10K)				
	Coil drain (A)	PT40 screw x 1				PT40 screw x 1				
Sound level (Note 11)	Control box side (dBA)	72.9				72.9				
	Coil side (dBA)	74.6				74.6				
	Water piping side (dBA)	68.6				68.6				
Required products sold separately	Module controller (MC)									

(Note 1) Rated conditions, such as capacity, electrical data, and standard flow rate are as follows.
 For cooling : 14°C entering water (EWT), 7°C leaving water (LWT), 35°CDB/24°CWD outdoor air (OAT) and 21°C feed-water temperature
 For heating : 38°C entering water (EWT), 45°C leaving water (LWT), 7°CDB/6°CWD outdoor air (OAT)
 Numbers in parenthesis indicate values for a difference of 5°C.
 For cooling: 12°C entering water (EWT), 7°C leaving water (LWT)
 For heating: 38°C entering water (EWT), 45°C leaving water (LWT)
 Same capacities, outdoor air temperature, and supplied water temperature (only for High EER type) as indicated above.
 Design water flow rate must be within the range of 5 to 10°C water temperature differences. Capacities and performance values are based on AHRI550-590.

(Note 2) Dimensions do not include projections of water pipe connections.
 (Note 3) Even when there is a fluctuation in supply voltage, do not exceed ±10% and keep imbalances between the supply voltages within 2%.
 (Note 4) Always install an earth leakage circuit breaker. This machine includes an inverter, so please use a high-frequency-compatible product to prevent malfunction.
 (Note 5) Power factors may vary depending on site conditions.
 (Note 6) The indicated value for IPLV (Integrated Part Load Value, cooling) is based on the AHRI550-590 "Water Chilling Unit".
 (Note 7) The supply water quality may cause scales and other matter to adhere to the coil surface. If necessary, install a water softener on the supply water side. (Provided locally)
 (Note 8) Adjust the flow rate to become close to this supply water pressure with the manual flow adjustment valve on the water spray system inlet. If sufficient supply water pressure is not available, install a pressure pump. (Provided locally)
 (Note 9) Working pressure : below 0.98 MPa.
 (Note 10) Range of capacity control sometimes can vary depending on the unit's operating condition.
 (Note 11) (Measurement position: Distance of 1.0m, height of 1.5m) The on-site sound level will be higher due to the affection of back noise and sound reflection.

Perspective on of Set Specifications (Calculation Method)

Ex.) Internal inverter pump Air-cooled heat pump [High-EER type] 16 combined module units

		Ex.) 60HP x1(single unit)	Ex.) 60HP x16 units	Calculation method	
Model (A single module unit)		RUA-UP511HN1-S	RUA-UP511HN1-S x16 units		
Cooling capacity (Note 1) (kW)		180	2,880	See General Charts or (single unit value) x (number of module units in set)	
Heating capacity (Note 1) (kW)		180	2,880	—	
Exterior	Unit color		Silky shade (Munsell 1Y8.5/0.5)		
	Dimensions (Note 2)	Height (mm)	2,350	See General Charts	
		Width (Note 2) (mm)	1,000		
		Depth (Note 2) (mm)	3,300		
Shipping weight (kg)		1,330	21,280	(Single unit value) x (number of module units in set)	
Operating weight (kg)		1,366	21,856	(Single unit value) x (number of module units in set)	
Power supply (Note 1-3)		3-phase 3-wire 380V 50/60Hz			
Reference current for power supply design (Note 4-5) (A)		196	196 x 16	(Single unit value) x (number of module units in set)	
Electrical data (Note 1-6)	Cooling	Nominal current (A)	58.5 (60.6)	936 (970)	(Single unit value) x (number of module units in set)
		Nominal input (kW)	38.1 (39.5)	610 (632)	(Single unit value) x (number of module units in set)
		EER	4.72 (4.56)	4.72 (4.56)	—
		Power factor (Note 7) (%)	99	99	—
	Heating	Nominal current (A)	82.4 (83.5)	1,318 (1,336)	(Single unit value) x (number of module units in set)
		Nominal input (kW)	53.7 (54.4)	860 (871)	(Single unit value) x (number of module units in set)
		COP	3.35 (3.31)	3.35 (3.31)	—
		Power factor (Note 7) (%)	99	99	—
IPLV (With a 5°C difference) (Note 8)		6.4	6.4	—	
Compressor	Type		Hermetic rotary		
	Model name		RA1000A4F-11UC		
	Motor output x number of units (kW)		11.9 x 4	11.9 x 64	(Single unit value) x (number of module units in set)
	Type of start		Inverter starter		
	Case heater (W)		37 x 4	37 x 64	(Single unit value) x (number of module units in set)
Compressor oil	Type		RB74AF		
	Charge (L)		2.0 x 4	2.0 x 64	(Single unit value) x (number of module units in set)
Condenser coil - air side		Plate fin coil			
Fan	Type		Propeller fan		
	Air quantity (m ³ /min)		1,230 (maximum)	19,680 (maximum)	(Single unit value) x (number of module units in set)
	Type of start		Inverter starter		
	Motor output x number of units (kW)		1.2 x 4	1.2 x 64	(Single unit value) x (number of module units in set)
Water spray system (Note 9)	Water spray volume (L/min)		13.6 x 1	13.6 x 16	(Single unit value) x (number of module units in set)
	Supply water pressure (Note 10) (MPa)		0.2	0.2	—
	Control		Continuous water spraying when outside temperature exceeds setting and compressor capacity exceeds setting		
	Motor output (kW)		1.5	1.5 x 16	(Single unit value) x (number of module units in set)
Pump (Note 4)	Type		Centrifugal pump		
	Flow control		Inverter		
	Maximum current (A)		6.1	6.1 x 16	(Single unit value) x (number of module units in set)
	Maximum input (kW)		2.0	2.0 x 16	(Single unit value) x (number of module units in set)
Cooler - water side (Note 11)		Brazed plate heat exchanger (SUS316 equivalent)			
Refrigerant	Type		R410A		
	R410 charge (kg)		10.6 x 4	10.6 x 64	(Single unit value) x (number of module units in set)
	Control		Electric expansion valve		
Capacity control steps (Note 12) (%)		0.5 ~ 100			
Operation control		Microprocessor control based on leaving water temperature and temperature difference			
Defrost system		Distributed reverse cycle system			
Protective device		High-pressure switch, Over current protection, Inverter overload protection (compressor, fan, pump), Crankcase heater, Open-phase protection, Microprocessor control (compressor time guards, freeze protection, high water temp. cutout, low flow rate, discharge gas overheat protection, low pressure cutout, thermistor error, high water pressure error)			
Piping/panels/Sound level (Note 13)	Cold/Hot water inlet (A)	65 flange x 1 (JIS10K)	65 flange x 1 (JIS10K)	(Single unit value) x (number of module units in set) *Each module unit has one connection port	
	Cold/Hot water outlet (A)	65 flange x 1 (JIS10K)	65 flange x 1 (JIS10K)		
	Coil drain (A)	PT40 screw x 1	PT40 screw x 16		
	Control box side (dBA)	72.9	80.9	See General Charts	
Coil side (dBA)	74.0	76.8			
Water piping side (dBA)		70.2	78.2		
Required products sold separately		Module controller (MC) (include external sensor x 2) (Note 14)		—	

(Note 1) Rated conditions, such as capacity, electrical data, and standard flow rate are as follows.
 For cooling : 14°C entering water (EWT), 7°C leaving water (LWT), 35°C DB/24°C WDW outdoor air (OAT) and 21°C feed-water temperature
 For heating : 38°C entering water (EWT), 45°C leaving water (LWT), 7°C DB/6°C WDW outdoor air (OAT)
 Numbers in parenthesis indicate values for a difference of 5°C.
 For cooling: 12°C entering water (EWT), 7°C leaving water (LWT)
 For heating: 38°C entering water (EWT), 45°C leaving water (LWT)
 Same capacities, outdoor air temperature, and supplied water temperature (only for High EER type) as indicated above.
 Design water flow rate must be within the range of 5 to 10°C water temperature differences. Capacities and performance values are based on AHRI550-590.

(Note 2) Dimensions do not include projections of water pipe connections.

(Note 3) Even when there is a fluctuation in supply voltage, do not exceed ±10% and keep imbalances between the supply voltages within 2%.

(Note 4) Output of the integrated pump can change depending on the outlet pump head required to comply with the indent. The power supply design at that time differs from those of a standard pump.

(Note 5) Always install an earth leakage circuit breaker. This machine includes an inverter, so please use a high-frequency-compatible product to prevent malfunction.

(Note 6) Note that electrical data do not include internal pump.

(Note 7) Power factors may vary depending on site conditions.

(Note 8) The indicated value for IPLV (Integrated Part Load Value, cooling) is based on the AHRI550-590 "Water Chilling Unit".

(Note 9) The supply water quality may cause scales and other matter to adhere to the coil surface. If necessary, install a water softener on the supply water side. (Provided locally)

(Note 10) Adjust the flow rate to become close to this supply water pressure with the manual flow adjustment valve on the water spray system inlet. If sufficient supply water pressure is not available, install a pressure pump. (Provided locally)

(Note 11) Working pressure : below 0.7 MPa.

(Note 12) Range of capacity control sometimes can vary depending on the unit's operating condition.

(Note 13) (Measurement position: Distance of 1.0m, height of 1.5m) The on-site sound level will be higher due to the affection of back noise and sound reflection.

(Note 14) The external sensor's lead wire length is 30 m.

General Charts for Combined module units : Capacity, Outside Dimensions, and Sound Level

60HP model

(Note 1)	Cooling capacity (kW)	Heating capacity (kW) (Note 2)	Dimensions (mm) H×W×D (Note 3)	Sound level (dBA) (Note 4)		
				Control box side	Air heat exchanger side	Water heat exchange side
RUA-UP511(H)(L)(N)#	180	180	2,350×1,000×3,300	72.9	74.0	70.2
RUA-UP511(H)(L)(N)# x 2 units	360	360	2,350×2,030×3,300	75.7	75.3	73.0
RUA-UP511(H)(L)(N)# x 3 units	540	540	2,350×3,060×3,300	77.3	75.8	74.5
RUA-UP511(H)(L)(N)# x 4 units	720	720	2,350×4,090×3,300	78.2	76.1	75.5
RUA-UP511(H)(L)(N)# x 5 units	900	900	2,350×5,120×3,300	78.9	76.3	76.1
RUA-UP511(H)(L)(N)# x 6 units	1,080	1,080	2,350×6,150×3,300	79.3	76.4	76.6
RUA-UP511(H)(L)(N)# x 7 units	1,260	1,260	2,350×7,180×3,300	79.7	76.5	77.0
RUA-UP511(H)(L)(N)# x 8 units	1,440	1,440	2,350×8,210×3,300	80.0	76.6	77.2
RUA-UP511(H)(L)(N)# x 9 units	1,620	1,620	2,350×9,240×3,300	80.2	76.6	77.4
RUA-UP511(H)(L)(N)# x 10 units	1,800	1,800	2,350×10,270×3,300	80.4	76.7	77.6
RUA-UP511(H)(L)(N)# x 11 units	1,980	1,980	2,350×11,300×3,300	80.5	76.7	77.8
RUA-UP511(H)(L)(N)# x 12 units	2,160	2,160	2,350×12,330×3,300	80.6	76.8	77.9
RUA-UP511(H)(L)(N)# x 13 units	2,340	2,340	2,350×13,360×3,300	80.7	76.8	78.0
RUA-UP511(H)(L)(N)# x 14 units	2,520	2,520	2,350×14,390×3,300	80.8	76.8	78.1
RUA-UP511(H)(L)(N)# x 15 units	2,700	2,700	2,350×15,420×3,300	80.9	76.8	78.1
RUA-UP511(H)(L)(N)# x 16 units	2,880	2,880	2,350×16,450×3,300	80.9	76.8	78.2

70HP model

(Note 1)	Cooling capacity (kW)	Heating capacity (kW) (Note 2)	Dimensions (mm) H×W×D (Note 3)	Sound level (dBA) (Note 4)		
				Control box side	Air heat exchanger side	Water heat exchange side
RUA-UP561(H)(L)(N)#	200	200	2,350×1,000×3,300	72.9	74.6	68.6
RUA-UP561(H)(L)(N)# x 2 units	400	400	2,350×2,030×3,300	75.8	75.9	71.5
RUA-UP561(H)(L)(N)# x 3 units	600	600	2,350×3,060×3,300	77.3	76.4	73.0
RUA-UP561(H)(L)(N)# x 4 units	800	800	2,350×4,090×3,300	78.2	76.7	73.9
RUA-UP561(H)(L)(N)# x 5 units	1,000	1,000	2,350×5,120×3,300	78.9	76.9	74.6
RUA-UP561(H)(L)(N)# x 6 units	1,200	1,200	2,350×6,150×3,300	79.4	77.0	75.1
RUA-UP561(H)(L)(N)# x 7 units	1,400	1,400	2,350×7,180×3,300	79.7	77.1	75.4
RUA-UP561(H)(L)(N)# x 8 units	1,600	1,600	2,350×8,210×3,300	80.0	77.2	75.7
RUA-UP561(H)(L)(N)# x 9 units	1,800	1,800	2,350×9,240×3,300	80.2	77.2	75.9
RUA-UP561(H)(L)(N)# x 10 units	2,000	2,000	2,350×10,270×3,300	80.4	77.3	76.1
RUA-UP561(H)(L)(N)# x 11 units	2,200	2,200	2,350×11,300×3,300	80.5	77.3	76.2
RUA-UP561(H)(L)(N)# x 12 units	2,400	2,400	2,350×12,330×3,300	80.6	77.3	76.3
RUA-UP561(H)(L)(N)# x 13 units	2,600	2,600	2,350×13,360×3,300	80.7	77.4	76.4
RUA-UP561(H)(L)(N)# x 14 units	2,800	2,800	2,350×14,390×3,300	80.8	77.4	76.5
RUA-UP561(H)(L)(N)# x 15 units	3,000	3,000	2,350×15,420×3,300	80.9	77.4	76.6
RUA-UP561(H)(L)(N)# x 16 units	3,200	3,200	2,350×16,450×3,300	81.0	77.4	76.7

Note 1: The power supply voltage specification (1: 380V, 2: 400V, 3: 415V, 4: 440V) is entered in the "#" in the table.

Note 2: Only for heat pump types.

Note 3: Dimensions (width, depth) do not include projections of water pipe connections and power cable kit. (when installing optional parts)

Note 4: The on-site sound level will be higher due to the affection of back noise and sound reflection.

General Charts for Combined module units : Standard Water Flow Rate / Water Volume Range (Leaving (LVG)/Entering (ETG) water temperature difference = 7°C)

Internal inverter pump

60HP model

(Note 1)	Standard flow rate (L/min) (Note 2)	Flow rate range (L/min) (Note 3-6)	Minimum water loop volume (L) (Note 4-5-6)	In-unit water volume (L)
RUA-UP511(H)(N)#	369	150~600	860	36
RUA-UP511(H)(N)# x 2 units	737	150~1,200		72
RUA-UP511(H)(N)# x 3 units	1,106	150~1,800		108
RUA-UP511(H)(N)# x 4 units	1,474	150~2,400		144
RUA-UP511(H)(N)# x 5 units	1,843	150~3,000		180
RUA-UP511(H)(N)# x 6 units	2,211	150~3,600		216
RUA-UP511(H)(N)# x 7 units	2,580	150~4,200		252
RUA-UP511(H)(N)# x 8 units	2,949	150~4,800		288
RUA-UP511(H)(N)# x 9 units	3,317	150~5,400		324
RUA-UP511(H)(N)# x 10 units	3,686	150~6,000		360
RUA-UP511(H)(N)# x 11 units	4,054	150~6,600		396
RUA-UP511(H)(N)# x 12 units	4,423	150~7,200		432
RUA-UP511(H)(N)# x 13 units	4,791	150~7,800		468
RUA-UP511(H)(N)# x 14 units	5,160	150~8,400		504
RUA-UP511(H)(N)# x 15 units	5,529	150~9,000		540
RUA-UP511(H)(N)# x 16 units	5,897	150~9,600		570

70HP model

(Note 1)	Standard flow rate (L/min) (Note 2)	Flow rate range (L/min) (Note 3-6)	Minimum water loop volume (L) (Note 4-5-6)	In-unit water volume (L)
RUA-UP561(H)(N)#	410	150~650	956	36
RUA-UP561(H)(N)# x 2 units	819	150~1,300		72
RUA-UP561(H)(N)# x 3 units	1,229	150~1,950		108
RUA-UP561(H)(N)# x 4 units	1,638	150~2,600		144
RUA-UP561(H)(N)# x 5 units	2,048	150~3,250		180
RUA-UP561(H)(N)# x 6 units	2,457	150~3,900		216
RUA-UP561(H)(N)# x 7 units	2,867	150~4,550		252
RUA-UP561(H)(N)# x 8 units	3,276	150~5,200		288
RUA-UP561(H)(N)# x 9 units	3,686	150~5,850		324
RUA-UP561(H)(N)# x 10 units	4,095	150~6,500		360
RUA-UP561(H)(N)# x 11 units	4,505	150~7,150		396
RUA-UP561(H)(N)# x 12 units	4,914	150~7,800		432
RUA-UP561(H)(N)# x 13 units	5,324	150~8,450		468
RUA-UP561(H)(N)# x 14 units	5,733	150~9,100		504
RUA-UP561(H)(N)# x 15 units	6,143	150~9,750		540
RUA-UP561(H)(N)# x 16 units	6,552	150~10,400		570

Note 1: The power supply voltage specification (1: 380V, 2: 400V, 3: 415V, 4: 440V) is entered in the "#" in the table.

Note 2: For both at cooling/heating. Indicates the flow rate and water pressure loss when leaving/entering water temperature difference is 7°C at rated capacity. (water pressure loss is only for pumpless models)

Note 3: Within the indicate flow rate range, the flow rate automatically changes from the pump integrated into each module. (only for internal inverter pump models)

Note 4: Value indicated for retained water amount is with a standard flow amount. (Rated capacity, change in water outlet/inlet temperature difference = 7°C)

When calculating the retained water amount, calculate the greatest water loss in the piping flow channel, giving consideration to the bypass channel etc.

Note 5: Please make a separate inquiry if you would like to control the effect of a temperature reduction in the water supply due to the defrost operation.

Note 6: When operating at the rated flow capacity, even with internal inverter pump models, set the flow amount range and system retained water amount to the same value as the pumpless model.

Pumpless

60HP model

(Note 1)	Standard flow rate · Water pressure loss (Note 2)		Flow rate range (L/min) (Note 5)	Minimum water loop volume (L) (Note 3-4-5)	In-unit water volume (L)
	(L/min)	(kPa)			
RUA-UP511(H)L(N)#	369	42.1	150~600	860	36
RUA-UP511(H)L(N)# x 2 units	737		300~1,200	1,720	72
RUA-UP511(H)L(N)# x 3 units	1,106		450~1,800	2,580	108
RUA-UP511(H)L(N)# x 4 units	1,474		600~2,400	3,440	144
RUA-UP511(H)L(N)# x 5 units	1,843		750~3,000	4,301	180
RUA-UP511(H)L(N)# x 6 units	2,211		900~3,600	5,161	216
RUA-UP511(H)L(N)# x 7 units	2,580		1,050~4,200	6,021	252
RUA-UP511(H)L(N)# x 8 units	2,949		1,200~4,800	6,881	288
RUA-UP511(H)L(N)# x 9 units	3,317		1,350~5,400	7,741	324
RUA-UP511(H)L(N)# x 10 units	3,686		1,500~6,000	8,601	360
RUA-UP511(H)L(N)# x 11 units	4,054		1,650~6,600	9,461	396
RUA-UP511(H)L(N)# x 12 units	4,423		1,800~7,200	10,321	432
RUA-UP511(H)L(N)# x 13 units	4,791		1,950~7,800	11,181	468
RUA-UP511(H)L(N)# x 14 units	5,160		2,100~8,400	12,041	504
RUA-UP511(H)L(N)# x 15 units	5,529		2,250~9,000	12,902	540
RUA-UP511(H)L(N)# x 16 units	5,897		2,400~9,600	13,762	570

70HP model

(Note 1)	Standard flow rate · Water pressure loss (Note 2)		Flow rate range (L/min) (Note 5)	Minimum water loop volume (L) (Note 3-4-5)	In-unit water volume (L)
	(L/min)	(kPa)			
RUA-UP511(H)L(N)#	410	51.3	150~650	956	36
RUA-UP511(H)L(N)# x 2 units	819		300~1,300	1,911	72
RUA-UP511(H)L(N)# x 3 units	1,229		450~1,950	2,867	108
RUA-UP511(H)L(N)# x 4 units	1,638		600~2,600	3,823	144
RUA-UP511(H)L(N)# x 5 units	2,048		750~3,250	4,778	180
RUA-UP511(H)L(N)# x 6 units	2,457		900~3,900	5,734	216
RUA-UP511(H)L(N)# x 7 units	2,867		1,050~4,550	6,690	252
RUA-UP511(H)L(N)# x 8 units	3,276		1,200~5,200	7,645	288
RUA-UP511(H)L(N)# x 9 units	3,686		1,350~5,850	8,601	324
RUA-UP511(H)L(N)# x 10 units	4,095		1,500~6,500	9,557	360
RUA-UP511(H)L(N)# x 11 units	4,505		1,650~7,150	10,512	396
RUA-UP511(H)L(N)# x 12 units	4,914		1,800~7,800	11,468	432
RUA-UP511(H)L(N)# x 13 units	5,324		1,950~8,450	12,424	468
RUA-UP511(H)L(N)# x 14 units	5,733		2,100~9,100	13,379	504
RUA-UP511(H)L(N)# x 15 units	6,143		2,250~9,750	14,335	540
RUA-UP511(H)L(N)# x 16 units	6,552		2,400~10,400	15,291	570

Note 1: The power supply voltage specification (1: 380V, 2: 400V, 3: 415V, 4: 440V) is entered in the "#" in the table.

Note 2: For both at cooling/heating. Indicates the flow rate and water pressure loss when leaving/entering water temperature difference is 7°C at rated capacity. (water pressure loss is only for pumpless models)

Note 3: Within the indicate flow rate range, the flow rate automatically changes from the pump integrated into each module. (only for internal inverter pump models)

Note 4: Value indicated for retained water amount is with a standard flow amount. (Rated capacity, change in water outlet/inlet temperature difference = 7°C)

When calculating the retained water amount, calculate the greatest water loss in the piping flow channel, giving consideration to the bypass channel etc.

Note 5: Please make a separate inquiry if you would like to control the effect of a temperature reduction in the water supply due to the defrost operation.

Note 6: When operating at the rated flow capacity, even with internal inverter pump models, set the flow amount range and system retained water amount to the same value as the pumpless model.

Capacity Chart / Standard Type (Leaving (LVG) / Entering (ETG) water temperature difference = 7°C)

60HP model

List of cooling capacities RUA-UP511 (H) (L)

LVG cold-water temperature (°C)	Item	Outdoor air temperature (°C) (DB)						
		15	20	25	30	35	40	43
4	Cooling capacity(kW)	217	205	191	176	165	155	149
	Nominal input (kW)	37.9	41.9	45.9	50.0	54.7	59.7	62.6
	Water flow rate (L/min)	444	420	391	360	338	317	305
	Nominal current (A)	58.2	64.4	70.5	76.8	84.0	91.7	96.1
7	Cooling capacity (kW)	234	224	209	193	180	169	159
	Nominal input (kW)	39.3	43.2	47.4	51.8	56.6	61.9	63.1
	Water flow rate (L/min)	479	459	428	395	369	346	326
	Nominal current (A)	60.3	66.3	72.9	79.5	86.9	95.0	96.9
9	Cooling capacity (kW)	243	238	222	205	190	178	165
	Nominal input (kW)	40.2	44.0	48.4	53.0	57.9	63.0	63.1
	Water flow rate (L/min)	498	487	455	420	389	364	338
	Nominal current (A)	61.7	67.6	74.4	81.3	88.8	96.7	96.9
12	Cooling capacity (kW)	253	251	241	223	206	190	175
	Nominal input (kW)	42.0	45.0	49.9	54.6	59.6	63.8	63.3
	Water flow rate (L/min)	*516	*516	493	457	422	389	358
	Nominal current (A)	64.5	69.1	76.6	83.8	91.5	98.0	97.1
15	Cooling capacity (kW)	261	261	253	237	220	200	185
	Nominal input (kW)	44.1	45.9	50.7	55.9	61.1	64.1	63.4
	Water flow rate (L/min)	*516	*516	*516	485	450	410	377
	Nominal current (A)	67.7	70.5	77.9	85.8	93.8	98.4	97.4
20	Cooling capacity (kW)	261	261	254	240	226	205	190
	Nominal input (kW)	44.1	45.9	50.8	56.2	61.5	64.2	63.5
	Water flow rate (L/min)	*516	*516	*516	491	463	420	389
	Nominal current (A)	67.7	70.5	78.0	86.3	94.5	98.6	97.6
25	Cooling capacity (kW)	261	261	254	240	226	206	190
	Nominal input (kW)	44.1	45.9	50.8	56.2	61.5	64.2	63.5
	Water flow rate (L/min)	*516	*516	*516	491	463	422	389
	Nominal current (A)	67.7	70.5	78.0	86.3	94.4	98.6	97.5
30	Cooling capacity (kW)	261	261	254	241	225	206	190
	Nominal input (kW)	44.1	45.9	50.8	56.2	61.1	64.2	63.5
	Water flow rate (L/min)	*516	*516	*516	491	461	422	389
	Nominal current (A)	67.7	70.5	78.0	86.3	93.8	98.6	97.5

List of heating capacities RUA-UP511H (L)

LVG hot-water temperature (°C)	Item	Outdoor air temperature (°C) (DB)							
		-15	-10	-5	0	4	7	15	
25	Heating capacity (kW)	98.8	116	135	157	175	187	223	
	Nominal input (kW)	32.0	33.9	35.3	36.5	37.2	36.9	37.3	
	Water flow rate (L/min)	202	238	276	321	358	381	457	
	Nominal current (A)	50.1	52.8	54.9	56.5	57.4	57.0	57.4	
30	Heating capacity (kW)	98.5	115	135	156	174	185	221	
	Nominal input (kW)	34.1	36.1	37.9	39.5	40.5	40.5	41.6	
	Water flow rate (L/min)	202	235	276	319	356	379	453	
	Nominal current (A)	53.2	56.2	58.8	61.1	62.5	62.4	63.9	
35	Heating capacity (kW)	98.0	115	134	155	172	184	219	
	Nominal input (kW)	36.5	38.9	41.0	43.0	44.3	44.5	46.3	
	Water flow rate (L/min)	201	235	274	317	352	377	448	
	Nominal current (A)	56.9	60.4	63.6	66.4	68.4	68.4	71.0	
40	Heating capacity (kW)	97.4	114	133	154	171	182	217	
	Nominal input (kW)	39.2	42.0	44.5	46.9	48.6	48.9	51.3	
	Water flow rate (L/min)	199	233	272	315	350	373	444	
	Nominal current (A)	61.0	65.2	68.9	72.4	74.8	75.2	78.7	
45	Heating capacity (kW)	96.8	113	132	152	169	180	214	
	Nominal input (kW)	42.1	45.3	48.3	51.1	53.2	53.7	56.6	
	Water flow rate (L/min)	198	231	270	311	346	369	438	
	Nominal current (A)	65.5	70.3	74.7	78.9	81.6	82.4	86.9	
50	Heating capacity (kW)		112	130	151	168	178	211	
	Nominal input (kW)		48.9	52.3	55.6	58.0	58.7	62.1	
	Water flow rate (L/min)		229	266	309	344	364	432	
	Nominal current (A)		75.7	80.8	85.7	89.1	90.1	95.4	
55	Heating capacity (kW)			129	150	166	175	200	
	Nominal input (kW)			56.4	60.3	62.7	63.5	63.8	
	Water flow rate (L/min)			264	307	340	358	410	
	Nominal current (A)			87.1	92.6	96.2	97.5	97.9	

- Note 1: The indicated cooling characteristics are when leaving/entering cold-water temperature difference is 7°C.
- Note 2: Performance shown for when machine operated on rated frequency.
- Note 3: * mark indicates max. Flow rate due to flow rate limitation. For max/ flow rate, leaving/entering temperature difference is 7°C or more.
- Note 4: The indicated heating characteristics are when leaving/entering hot-water temperature difference is 7°C.
- Note 5: The maximum output is displayed (however, this range does not go over the rated output). Other values indicates the performance when the machine is operating at its rated frequency.
- Note 6: The indicated heating characteristics indicate performance with a relative humidity difference of 85%.
- Note 7: In case the nominal current is 380V.

70HP model

List of cooling capacities RUA-UP561 (H) (L)

LVG cold-water temperature (°C)	Item	Outdoor air temperature (°C) (DB)						
		15	20	25	30	35	40	43
4	Cooling capacity (kW)	243	227	211	195	184	173	165
	Nominal input (kW)	48.5	53.1	57.6	62.3	68.0	74.1	76.2
	Water flow rate (L/min)	498	465	432	399	377	354	338
	Nominal current (A)	74.8	81.5	88.4	95.7	104	114	117
7	Cooling capacity (kW)	260	248	232	213	200	188	175
	Nominal input (kW)	49.6	54.8	59.9	64.8	70.7	76.5	76.4
	Water flow rate (L/min)	532	508	475	436	410	385	358
	Nominal current (A)	76.1	84.2	92.0	99.6	109	118	117
9	Cooling capacity (kW)	271	261	244	227	211	197	183
	Nominal input (kW)	50.8	55.8	61.2	66.6	72.4	77.2	76.5
	Water flow rate (L/min)	555	534	500	465	432	403	375
	Nominal current (A)	78.0	85.7	94.0	102	111	119	118
12	Cooling capacity (kW)	283	276	262	245	229	210	194
	Nominal input (kW)	52.4	56.9	62.9	68.8	75.5	77.8	76.8
	Water flow rate (L/min)	*573	565	536	502	469	430	397
	Nominal current (A)	80.4	87.4	96.6	106	116	119	118
15	Cooling capacity (kW)	286	283	270	256	240	219	203
	Nominal input (kW)	53.1	57.4	63.7	70.0	77.7	78.2	77.2
	Water flow rate (L/min)	*573	*573	553	522	491	448	416
	Nominal current (A)	81.5	88.1	97.8	108	119	120	119
20	Cooling capacity (kW)	286	283	270	256	242	222	207
	Nominal input (kW)	53.1	57.4	63.7	70.1	76.8	78.3	77.4
	Water flow rate (L/min)	*573	*573	553	524	496	455	424
	Nominal current (A)	81.5	88.1	97.8	108	118	120	119
25	Cooling capacity (kW)	286	283	270	256	242	222	207
	Nominal input (kW)	53.1	57.4	63.7	70.1	77.0	78.3	77.4
	Water flow rate (L/min)	*573	*573	553	524	496	455	424
	Nominal current (A)	81.5	88.1	97.8	108	118	120	119
30	Cooling capacity (kW)	286	282	270	256	242	222	206
	Nominal input (kW)	53.1	57.4	63.7	70.1	77.2	78.2	77.4
	Water flow rate (L/min)	*573	*573	553	524	496	455	422
	Nominal current (A)	81.5	88.1	97.8	108	119	120	119

List of heating capacities RUA-UP561H (L)

LVG hot-water temperature (°C)	Item	Outdoor air temperature (°C) (DB)							
		-15	-10	-5	0	4	7	15	
25	Heating capacity (kW)	121	141	164	191	200	207	247	
	Nominal input (kW)	43.8	46.0	48.1	49.9	45.7	43.3	44.2	
	Water flow rate (L/min)	248	289	336	391	410	424	506	
	Nominal current (A)	68.9	72.1	75.0	77.6	70.7	66.8	67.9	
30	Heating capacity (kW)	121	141	164	189	200	206	245	
	Nominal input (kW)	46.8	49.3	51.7	54.0	50.4	47.4	49.1	
	Water flow rate (L/min)	248	289	336	387	410	422	502	
	Nominal current (A)	73.6	77.2	80.6	83.8	78.0	73.1	75.4	
35	Heating capacity (kW)	121	140	163	188	200	204	242	
	Nominal input (kW)	50.2	53.1	55.9	58.6	55.9	52.0	54.4	
	Water flow rate (L/min)	248	287	334	385	410	418	496	
	Nominal current (A)	78.8	83.0	87.0	90.9	86.4	80.1	83.5	
40	Heating capacity (kW)	120	140	162	187	200	202	240	
	Nominal input (kW)	54.0	57.3	60.6	63.7	61.9	57.0	60.1	
	Water flow rate (L/min)	246	287	332	383	410	414	491	
	Nominal current (A)	84.5	89.4	94.1	98.7	95.5	87.6	92.2	
45	Heating capacity (kW)	120	139	161	185	200	200	237	
	Nominal input (kW)	57.9	61.8	65.6	69.3	68.5	62.5	66.2	
	Water flow rate (L/min)	246	285	330	379	410	410	485	
	Nominal current (A)	90.6	96.2	102	107	106	95.9	102	
50	Heating capacity (kW)		138	160	184	200	200	235	
	Nominal input (kW)		66.5	70.8	75.2	75.4	69.2	72.8	
	Water flow rate (L/min)		283	328	377	410	410	481	
	Nominal current (A)		196	208	221	221	202	212	
55	Heating capacity (kW)			159	179	193	200	228	
	Nominal input (kW)			76.4	77.9	77.9	76.2	77.0	
	Water flow rate (L/min)			326	367	395	410	467	
	Nominal current (A)			118	120	120	117	118	

- Note 1: The indicated cooling characteristics are when leaving/entering cold-water temperature difference is 7°C.
- Note 2: Performance shown for when machine operated on rated frequency.
- Note 3: * mark indicates max. Flow rate due to flow rate limitation. For max/ flow rate, leaving/entering temperature difference is 7°C or more.
- Note 4: The indicated heating characteristics are when leaving/entering hot-water temperature difference is 7°C.
- Note 5: The maximum output is displayed (however, this range does not go over the rated output). Other values indicates the performance when the machine is operating at its rated frequency.
- Note 6: The indicated heating characteristics indicate performance with a relative humidity difference of 85%.
- Note 7: In case the nominal current is 380V.

Capacity Chart / High-EER Type (LVG / ENG water temperature difference = 7°C)

60HP model

List of cooling capacities RUA-UP511 (H) (L) N

LVG cold-water temperature (°C)	Item	Outdoor air temperature (°C) (DB)			
		30	35	40	43
	Water spray	ON	ON	ON	ON
4	Cooling capacity (kW)	175	163	150	143
	Nominal input (kW)	33.7	37.5	41.4	45.2
	Water flow rate (L/min)	358	334	307	293
	Nominal current (A)	51.8	57.5	63.7	69.4
7	Cooling capacity (kW)	193	180	165	157
	Nominal input (kW)	33.9	38.1	42.3	46.0
	Water flow rate (L/min)	395	369	338	321
	Nominal current (A)	52.1	58.5	64.9	70.7
9	Cooling capacity (kW)	205	191	176	167
	Nominal input (kW)	34.3	38.3	42.7	46.6
	Water flow rate (L/min)	420	391	360	342
	Nominal current (A)	52.6	58.9	65.5	71.6
12	Cooling capacity (kW)	219	209	193	182
	Nominal input (kW)	35.3	38.9	43.3	47.4
	Water flow rate (L/min)	448	428	395	373
	Nominal current (A)	54.2	59.7	66.5	72.8
15	Cooling capacity (kW)	226	221	206	195
	Nominal input (kW)	36.3	39.0	43.9	47.9
	Water flow rate (L/min)	463	453	422	399
	Nominal current (A)	55.7	60.0	67.5	73.6
20	Cooling capacity (kW)	228	226	212	202
	Nominal input (kW)	36.9	39.1	44.1	48.4
	Water flow rate (L/min)	467	463	434	414
	Nominal current (A)	56.6	60.0	67.7	74.4
25	Cooling capacity (kW)	228	226	212	202
	Nominal input (kW)	36.9	39.1	44.1	48.4
	Water flow rate (L/min)	467	463	434	414
	Nominal current (A)	56.6	60.0	67.7	74.4
30	Cooling capacity (kW)	228	226	212	202
	Nominal input (kW)	36.9	39.1	44.1	48.4
	Water flow rate (L/min)	467	463	434	414
	Nominal current (A)	56.6	60.0	67.7	74.4

List of heating capacities RUA-UP511H (L) N

LVG hot-water temperature (°C)	Item	Outdoor air temperature (°C) (DB)						
		-15	-10	-5	0	4	7	15
25	Heating capacity (kW)	98.8	116	135	157	175	187	223
	Nominal input (kW)	32.0	33.9	35.3	36.5	37.2	36.9	37.3
	Water flow rate (L/min)	202	238	276	321	358	381	457
	Nominal current (A)	50.1	52.8	54.9	56.5	57.4	57.0	57.4
30	Heating capacity (kW)	98.5	115	135	156	174	185	221
	Nominal input (kW)	34.1	36.1	37.9	39.5	40.5	40.5	41.6
	Water flow rate (L/min)	202	235	276	319	356	379	453
	Nominal current (A)	53.2	56.2	58.8	61.1	62.5	62.4	63.9
35	Heating capacity (kW)	98.0	115	134	155	172	184	219
	Nominal input (kW)	36.5	38.9	41.0	43.0	44.3	44.5	46.3
	Water flow rate (L/min)	201	235	274	317	352	377	448
	Nominal current (A)	56.9	60.4	63.6	66.4	68.4	68.4	71.0
40	Heating capacity (kW)	97.4	114	133	154	171	182	217
	Nominal input (kW)	39.2	42.0	44.5	46.9	48.6	48.9	51.3
	Water flow rate (L/min)	199	233	272	315	350	373	444
	Nominal current (A)	61.0	65.2	68.9	72.4	74.8	75.2	78.7
45	Heating capacity (kW)	96.8	113	132	152	169	180	214
	Nominal input (kW)	42.1	45.3	48.3	51.1	53.2	53.7	56.6
	Water flow rate (L/min)	198	231	270	311	346	369	438
	Nominal current (A)	65.5	70.3	74.7	78.9	81.6	82.4	86.9
50	Heating capacity (kW)		112	130	151	168	178	211
	Nominal input (kW)		48.9	52.3	55.6	58.0	58.7	62.1
	Water flow rate (L/min)		229	266	309	344	364	432
	Nominal current (A)		75.7	80.8	85.7	89.1	90.1	95.4
55	Heating capacity (kW)			129	150	166	175	200
	Nominal input (kW)			56.4	60.3	62.7	63.5	63.8
	Water flow rate (L/min)			264	307	340	358	410
	Nominal current (A)			87.1	92.6	96.2	97.5	97.9

- Note 1: The indicated cooling characteristics are when leaving/entering cold-water temperature difference is 7°C.
- Note 2: Performance shown for when machine operated on rated frequency.
- Note 3: Cooling properties are for an outside relative humidity of 40% and a water spray system water supply temperature of 21° C.
- Note 4: The indicated heating characteristics are when leaving/entering hot-water temperature difference is 7°C.
- Note 5: The maximum output is displayed (however, this range does not go over the rated output). Other values indicates the performance when the machine is operating at its rated frequency.
- Note 6: The indicated heating characteristics indicate performance with a relative humidity difference of 85%.
- Note 7: In case the nominal current is 380V.

70HP model

List of cooling capacities RUA-UP561 (H) (L) N

LVG cold-water temperature (°C)	Item	Outdoor air temperature (°C) (DB)			
		30	35	40	43
	Water spray	ON	ON	ON	ON
4	Cooling capacity (kW)	195	181	168	160
	Nominal input (kW)	41.6	45.9	50.5	55.0
	Water flow rate (L/min)	399	371	344	328
	Nominal current (A)	63.8	70.4	77.6	84.4
7	Cooling capacity (kW)	216	200	184	175
	Nominal input (kW)	43.9	46.9	51.6	56.2
	Water flow rate (L/min)	442	410	377	358
	Nominal current (A)	67.4	72.0	79.3	86.3
9	Cooling capacity (kW)	230	213	196	186
	Nominal input (kW)	44.3	49.2	52.5	57.2
	Water flow rate (L/min)	471	436	401	381
	Nominal current (A)	68.1	75.6	80.6	87.8
12	Cooling capacity (kW)	245	233	215	202
	Nominal input (kW)	44.1	48.3	55.2	58.2
	Water flow rate (L/min)	502	477	440	414
	Nominal current (A)	67.7	74.1	84.8	89.4
15	Cooling capacity (kW)	254	247	229	218
	Nominal input (kW)	44.3	51.5	54.4	60.9
	Water flow rate (L/min)	520	506	469	446
	Nominal current (A)	68.1	79.1	83.5	93.5
20	Cooling capacity (kW)	254	248	233	222
	Nominal input (kW)	44.3	50.7	54.5	61.4
	Water flow rate (L/min)	520	508	477	455
	Nominal current (A)	68.1	77.9	83.7	94.2
25	Cooling capacity (kW)	254	248	233	223
	Nominal input (kW)	44.3	50.7	54.5	61.4
	Water flow rate (L/min)	520	508	477	457
	Nominal current (A)	68.1	77.9	83.7	94.2
30	Cooling capacity (kW)	254	248	234	223
	Nominal input (kW)	44.3	50.7	54.5	61.4
	Water flow rate (L/min)	520	508	479	457
	Nominal current (A)	68.1	77.9	83.7	94.2

List of heating capacities RUA-UP561H (L) N

LVG hot-water temperature (°C)	Item	Outdoor air temperature (°C) (DB)						
		-15	-10	-5	0	4	7	15
25	Heating capacity (kW)	121	141	164	191	200	207	247
	Nominal input (kW)	43.8	46.0	48.1	49.9	45.7	43.3	44.2
	Water flow rate (L/min)	248	289	336	391	410	424	506
	Nominal current (A)	68.9	72.1	75.0	77.6	70.7	66.8	67.9
30	Heating capacity (kW)	121	141	164	189	200	206	245
	Nominal input (kW)	46.8	49.3	51.7	54.0	50.4	47.4	49.1
	Water flow rate (L/min)	248	289	336	387	410	422	502
	Nominal current (A)	73.6	77.2	80.6	83.8	78.0	73.1	75.4
35	Heating capacity (kW)	121	140	163	188	200	204	242
	Nominal input (kW)	50.2	53.1	55.9	58.6	55.9	52.0	54.4
	Water flow rate (L/min)	248	287	334	385	410	418	496
	Nominal current (A)	78.8	83.0	87.0	90.9	86.4	80.1	83.5
40	Heating capacity (kW)	120	140	162	187	200	202	240
	Nominal input (kW)	54.0	57.3	60.6	63.7	61.9	57.0	60.1
	Water flow rate (L/min)	246	287	332	383	410	414	491
	Nominal current (A)	84.5	89.4	94.1	98.7	95.5	87.6	92.2
45	Heating capacity (kW)	120	139	161	185	200	200	237
	Nominal input (kW)	57.9	61.8	65.6	69.3	68.5	62.5	66.2
	Water flow rate (L/min)	246	285	330	379	410	410	485
	Nominal current (A)	90.6	96.2	102	107	106	95.9	102
50	Heating capacity (kW)		138	160	184	200	200	235
	Nominal input (kW)		66.5	70.8	75.2	75.4	69.2	72.8
	Water flow rate (L/min)		283	328	377	410	410	481
	Nominal current (A)		196	208	221	221	202	212
55	Heating capacity (kW)			159	179	193	200	228
	Nominal input (kW)			76.4	77.9	77.9	76.2	77.0
	Water flow rate (L/min)			326	367	395	410	467
	Nominal current (A)			118	120	120	117	118

- Note 1: The indicated cooling characteristics are when leaving/entering cold-water temperature difference is 7°C.
- Note 2: Performance shown for when machine operated on rated frequency.
- Note 3: Cooling properties are for an outside relative humidity of 40% and a water spray system water supply temperature of 21° C.
- Note 4: The indicated heating characteristics are when leaving/entering hot-water temperature difference is 7°C.
- Note 5: The maximum output is displayed (however, this range does not go over the rated output). Other values indicates the performance when the machine is operating at its rated frequency.
- Note 6: The indicated heating characteristics indicate performance with a relative humidity difference of 85%.
- Note 7: In case the nominal current is 380V.

60HP model, 70HP model Internal pump 60HZ performance curve

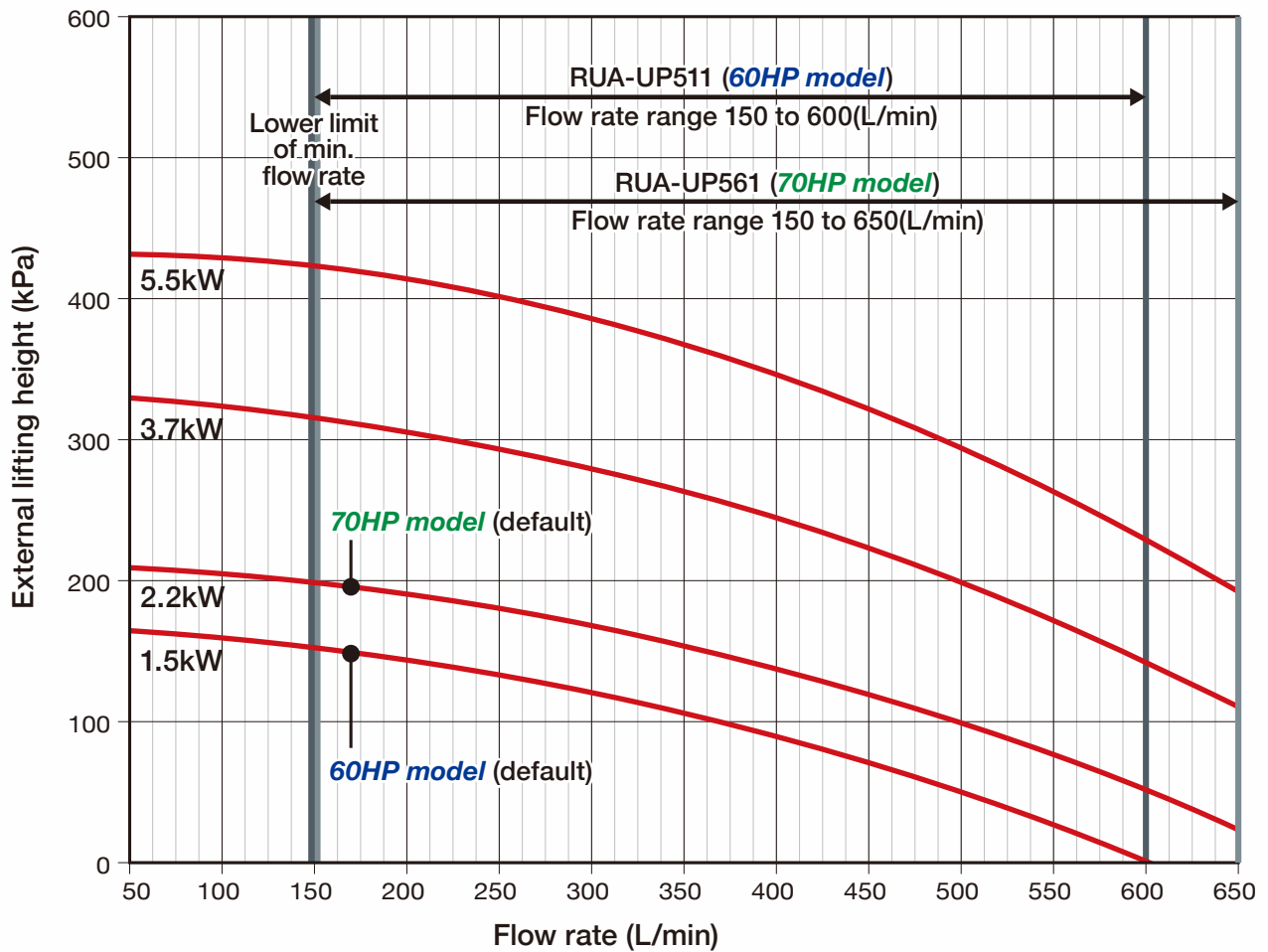

● Pump specification values

Pump output	60HP model				70HP model		
	1.5 (Standard)	2.2	3.7	5.5	2.2 (Standard)	3.7	5.5
Flow rate range ^(*) (L/min)	150~600				150~650		
External lifting height ^(**) (kPa)	43~151	92~198	190~315	284~422	64~198	158~315	247~422
Max. operation current ^(**) (A)	3.3	4.5	7.3	10.5	4.5	7.3	10.5
Max. power consumption ^(**) (kW)	2.0	2.8	4.5	6.4	2.8	4.5	6.4
Max. allowable boost pressure (MPa)	0.52	0.47	0.36	0.25	0.47	0.36	0.25
Max. suction head (water temp. 60°C or less) (kPa)	40	40	40	40	40	40	40

Note 1: Flow rate range (upper limit), max. current and max. power consumption in the table above are values for a pump. Multiply the number of pumps (modules) by these values depending on the unit size. When selecting anything other than rated output, you can also use values outside of the flow amount range shown in the graph. Use the formula below to find the flow amount range outside of the rated capacity.

Minimum flow rate=capacity x 860/60/10 (maximum temperature difference)
 *However, minimum flow amount must be at or above 75L/min
 Maximum flow amount=capacity x 860/60/5 (minimum temperature difference)
 *However, maximum flow amount must be at or below 600L/min for the 60HP model, and at or below 650L/min for the 70HP model

- Note 2: Lifting height outside of the unit shown in the table is the value when the pump frequency is 60Hz at the flow rate range above. The pump lift outside of the machine is the value reached when subtracting the resistance inside the machine from the total pump lift.
- Note 3: Max. current and max. power consumption are the max. values when the pump operation frequency is 60Hz.
- Note 4: 60Hz pumps are commonly used in the 50Hz area.
- Note 5: Select a pump that can handle the needed lift and flow amount.
- Note 6: In case the nominal current is 380V.

Pump Characteristics / Internal Resistance Curve (For pumpless)

Internal resistance curve (For pumpless) 60HP model, 70HP model

Note: For a unit without a pump, select a pump outside of the heat pump unit considering internal resistance below

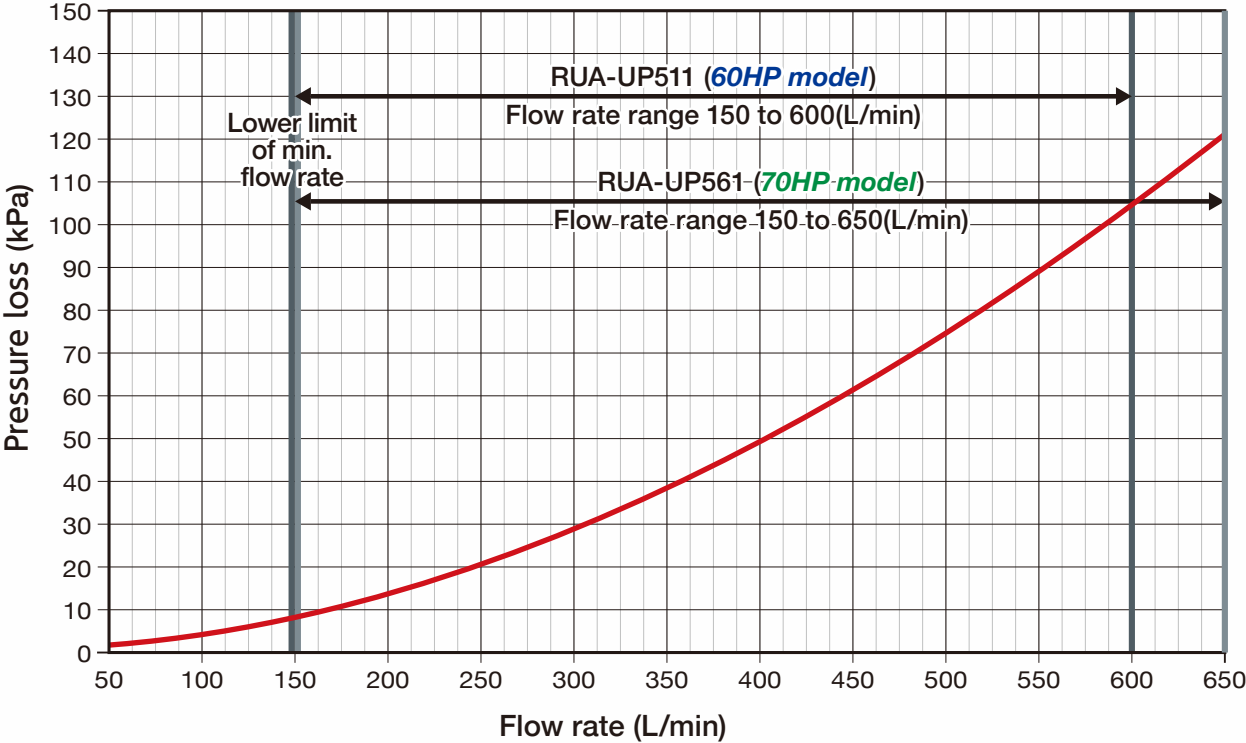

Operating Temperature Range

1. Operating ranges

60HP model 70HP model

Leaving water temperature <small>(Note 1)</small>	Cooling	°C	4~30
	Heating <small>(Note 2) (Note 3)</small>		25~55
	Temperature difference (inlet/outlet)		5~10
Outside air temperature	Cooling		-15~46
	Heating <small>(Note 2) (Note 3)</small>		-15~43DB, 32WB

Note 1: LWT not higher than 35°C at cooling or not lower than 20°C at heating operation is allowable till 1 hour after starting up. After then, however, LWT must be within the operating range. Control it with bypass pipe if needed.

Note 2: For heat pump models only.

Note 3: Depend on the outdoor air temperature, leaving hot water temperature is limited as below.

● Leaving hot-water temperature range

60HP model 70HP model

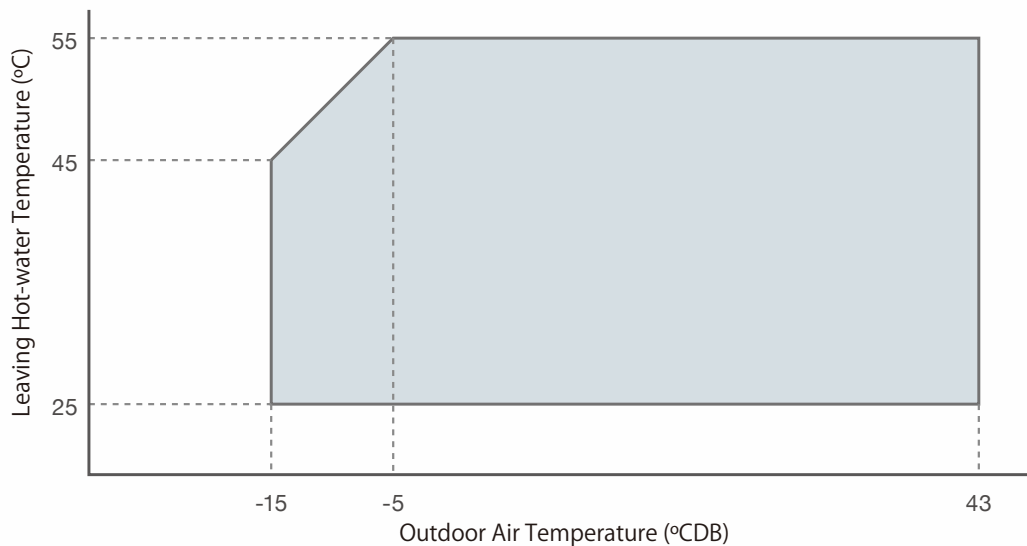

2. Operating range for water dispersing device

Water dispersing water temperature range	°C	10~30
Water dispersing preset outdoor air temperature	°C	20~40

Power Supply Design

Displayed below are the electrical power design specifications for each module unit.

※60HP model : Internal pump output for inverter units is 1.5kW (standard), and can be changed to 2.2, 3.7, and 5.5kW as special order.
 70HP model : Internal pump output for inverter units is 2.2kW (standard), and can be changed to 3.7, and 5.5kW as special order.

● Power supply design (380V/400V/415V/440V specifications) (Internal inverter pump/Pumpless) (Heat pump/Cooling-only) (Standard type and High-EER type in common)

		60HP model				70HP model					
Internal Pump	Power supply	50/60Hz 380V/400V/415V, 60Hz 440V				50/60Hz 380V/400V/415V, 60Hz 440V					
		Pumpless	Internal inverter pump				Pumpless	Internal inverter pump			
			Standard	For special order				Standard	For special order		
	Motor Output (kW)		1.5	2.2	3.7	5.5	2.2	3.7	5.5		
	Type	—	Centrifugal pump				—	Centrifugal pump			
	Type of start	—	Inverter start				—	Inverter start			
	Control	—	Inverter				—	Inverter			
	Max. Current (A)	—	3.1	4.3	6.9	10.0	—	4.3	6.9	10.0	
	Max. Input (kW)	—	2.0	2.8	4.5	6.4	—	2.8	4.5	6.4	
		No. of primary connecting part for power supply wiring	No. of power connection terminals inside each module(M10)				No. of power connection terminals inside each module(M10)				
Power Supply Design	Standard Current (A)	95	98	99	102	105	114	118	121	124	
	Power Source Capacity (kVA)	65.8	67.9	68.7	70.5	72.7	79.1	82.0	83.8	86.0	
	Power Supply Wiring (mm ²)	IV: Power Supply ≤ 20m (mm ²)	38				60	60			
		IV: Power Supply ≤ 50m (mm ²)	38				60	60			
		CV: Power Supply ≤ 20m (mm ²)	38					38			
		CV: Power Supply ≤ 50m (mm ²)	38					38			
	Ground (mm ²)	5.5	6		8		8				
	Switch (A)	100				125		125			
Fuse (A)	100				125		125				
Earth Leakage Circuit Breaker (Capacity) (A)	100				125		125				
Earth Leakage Circuit Breaker (Sensibility) (mA)	100				200		200				

*1. The internal pump can be replaced with another pump with appropriate output according to the lifting height outside of the unit required by a custom option. Since power supply design is different depending on the pump output, be sure to see the values in the corresponding field.

*2. The pump operates at a maximum frequency of 60 Hz at a maximum flow rate (per module).

*3. A leakage breaker must be installed. Use the one conformed to higher harmonic to prevent malfunction since this unit includes an inverter.

*4. Standard Current is the value considering the unbalance of 2% between power supply voltages.

- Fuse capacities in the tables are for B class fuses.
- Select a power supply transformer that can support values greater than those shown in the tables.
- Power supply line thickness values are for metal conduits with three or fewer wires inside a single conduit. (or six or fewer wires when two wires are used for one pole)
- Selected based on Japanese regulations. Select the appropriate unit based on the laws and regulations of the location where the unit is to be installed.

A single module unit

No.	Name	Connection
1	Water inlet	RUA-UP511 * 65A flange
		RUA-UP561 * 80A flange
2	Water outlet	RUA-UP511 * 65A flange
		RUA-UP561 * 80A flange
3	Coil drain piping connection port	PT40A external thread
4	Air vent valve port	PT15A internal thread
5	Strainer	Casing FC250-equivalent
6	Check valve	Casing FC200-equivalent
7	Water pipe (inlet)	JIS10K flange SUS304-equivalent
		Piping SUS304-equivalent
8	Water pipe (outlet)	JIS10K flange SUS304-equivalent
		Piping SUS304-equivalent
9	Pump	Casing FC200
10	Water heat exchanger	Plate / joint SUS316-equivalent
		Brazed part Pure copper
11	Housing joint +1	Gasket EPDM

*1 Water piping is shown above.

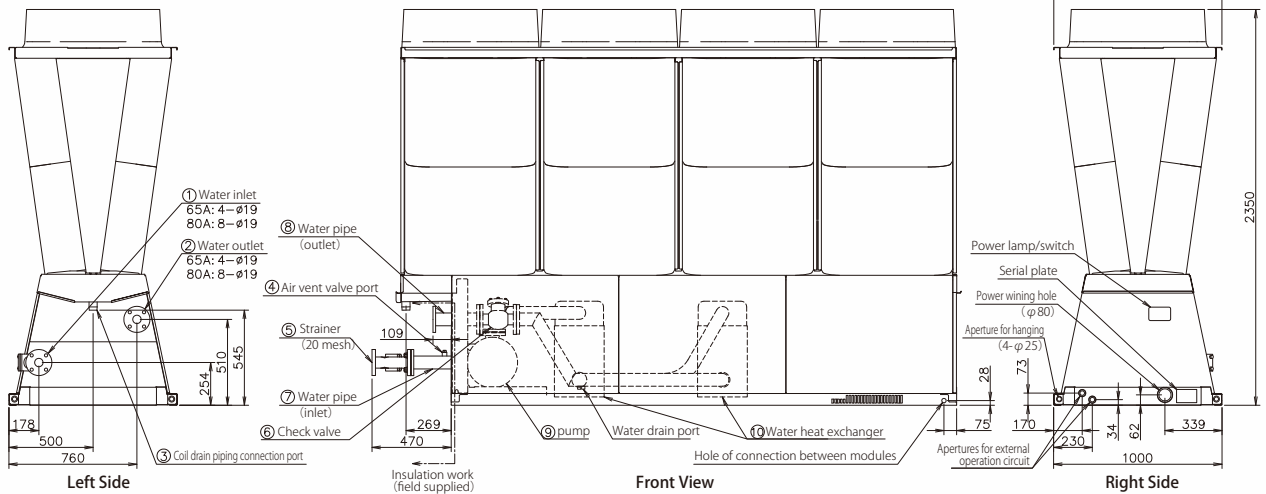
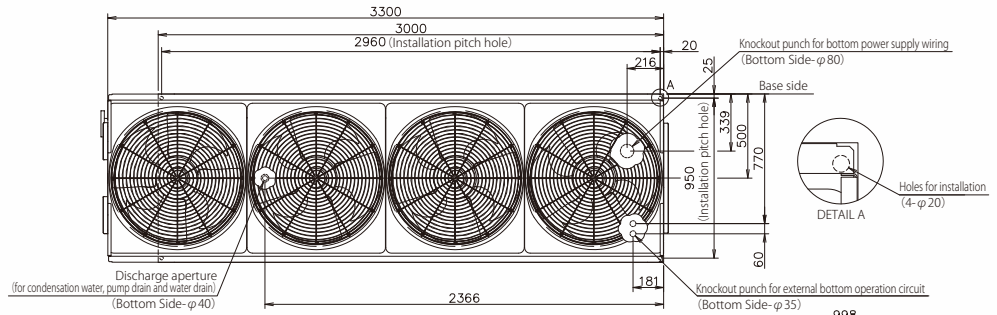

Combined installation

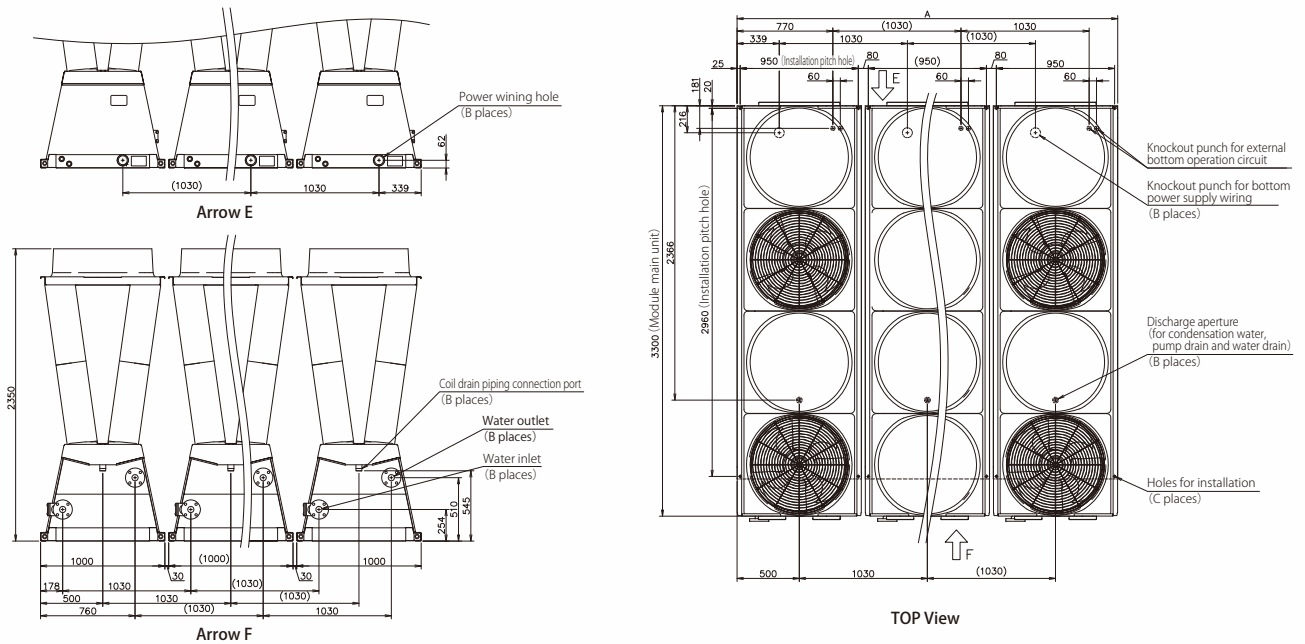

The number of modules	A	B	C	The number of modules	A	B	C	The number of modules	A	B	C	The number of modules	A	B	C
1 module	1000	1	4	5 modules	5120	5	20	9 modules	9240	9	36	13 modules	13360	13	52
2 modules	2030	2	8	6 modules	6150	6	24	10 modules	10270	10	40	14 modules	14390	14	56
3 modules	3060	3	12	7 modules	7180	7	28	11 modules	11300	11	44	15 modules	15420	15	60
4 modules	4090	4	16	8 modules	8210	8	32	12 modules	12330	12	48	16 modules	16450	16	64

Note1. For both 60HP model and 70HP model.
 Note2. The values indicated above are applied to A through C.

A single module unit

No.	Name	Connection
1	Water inlet	RUA-UP511 * 65A flange
		RUA-UP561 * 80A flange
2	Water outlet	RUA-UP511 * 65A flange
		RUA-UP561 * 80A flange
3	Coil drain piping connection port	PT40A external thread
4	Air vent valve port	PT15A internal thread
5	Strainer	Casing FC250-equivalent
6	Water pipe (inlet)	JIS10K flange SUS304-equivalent
		Piping SUS304-equivalent
7	Water pipe (outlet)	JIS10K flange SUS304-equivalent
		Piping SUS304-equivalent
8	Water heat exchanger	Plate / joint SUS316-equivalent
		Brazed part Pure copper
9	Housing joint * 1	Gasket EPDM

* 1 Water piping is shown above.

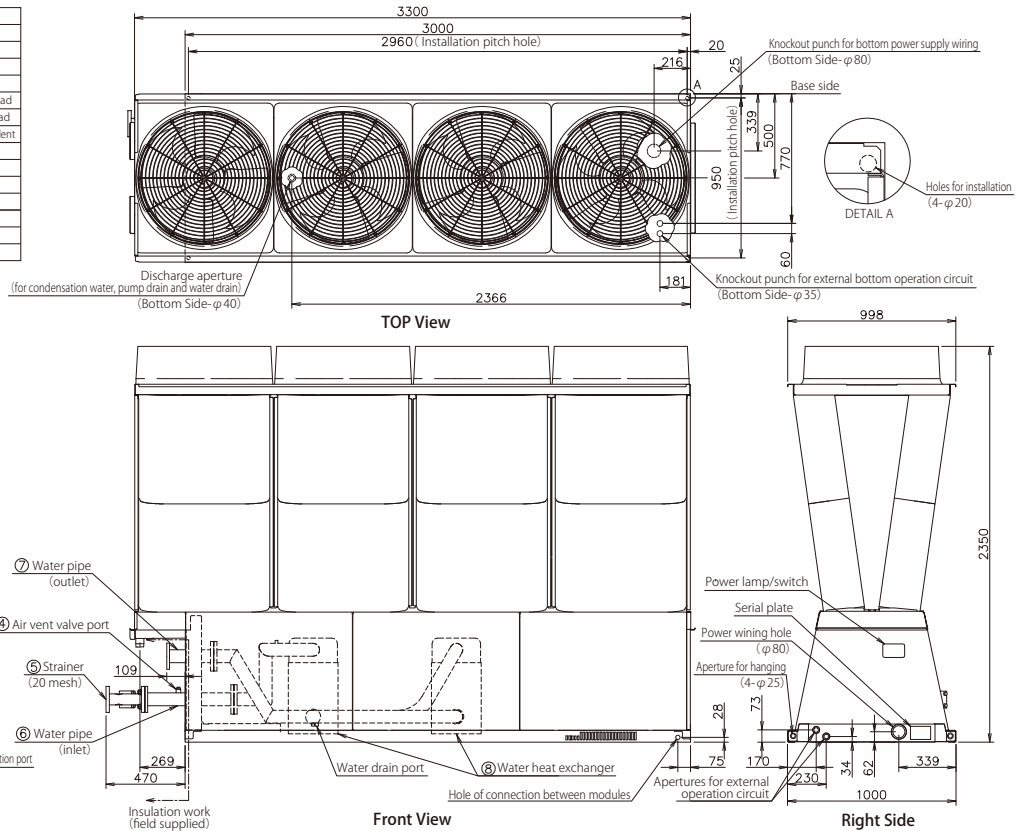

Combined installation

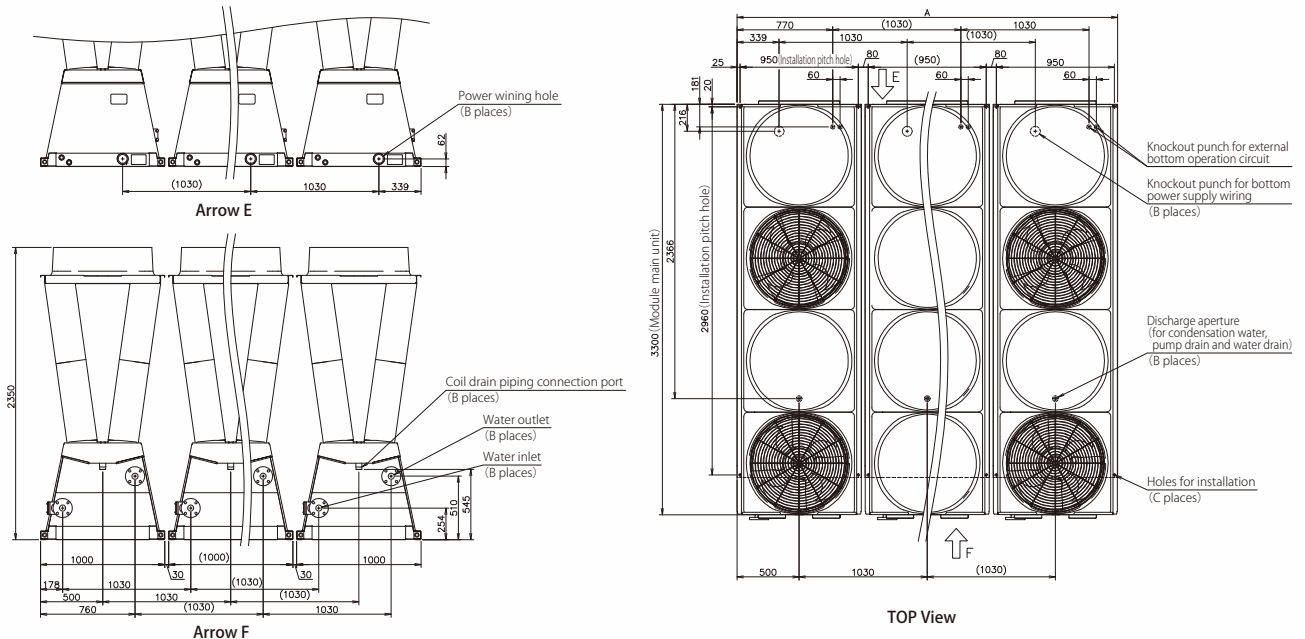

The number of modules	A	B	C	The number of modules	A	B	C	The number of modules	A	B	C	The number of modules	A	B	C
1 module	1000	1	4	5 modules	5120	5	20	9 modules	9240	9	36	13 modules	13360	13	52
2 modules	2030	2	8	6 modules	6150	6	24	10 modules	10270	10	40	14 modules	14390	14	56
3 modules	3060	3	12	7 modules	7180	7	28	11 modules	11300	11	44	15 modules	15420	15	60
4 modules	4090	4	16	8 modules	8210	8	32	12 modules	12330	12	48	16 modules	16450	16	64

Note1. For both 60HP model and 70HP model.
 Note2. The values indicated above are applied to A through C.

System Examples for Internal Inverter Pump Units

- When using a combination of several Heat Pumps, or combining with other heat pump units, a meeting about water provision must be held. Please contact us separately.
- As a cold (hot) water circulation pump is built in, test run adjustment which includes the whole piping system must be necessary. (Forced open/close of auto control valve in A/C is required.)
- The system detects the required flow rate on load side, and automatically fluctuates the number of internal cold (hot) water circulating pump and the operating frequency. Refer to "Pump Characteristics" and select an internal pump by considering the required max. flow rate and max. lifting for the system.
- Also consider construction on the suction side of internal pumps (boost pressure/pipe resistance). While internal pumps are stopped, ensure that the pressure on the suction side is not negative to prevent the air from entering the pumps from mechanical seals. Or ensure that the suction side main water pipes are higher than the heat pump cold (hot) water inlet piping to prevent the air from accumulating in the heat pump. Closer attention is required when an open-type tank is set up as an expansion tank on the heat pump inlet side.
- To improve energy saving abilities, we recommend that you make a variable flow system using 2 way valves on the secondary side etc.
- If the heat pump locates at the highest point in the system, install an automatic air vent valve (with a check valve function) at the inlet pipe for each module.
- Secure a sufficient holding water volume between the heat pump and the bypass circuit to ensure water temperature controllability. The water volume described in the specifications table is required to operate a module for two minutes, the minimum running time. The values in the table show the minimum holding water volume required to protect the unit. Ensure as much holding water volume as possible to minimize the variation of supply water temperature.
- Differential pressure regulating valves or flow meters may be required depending on the system. In that case, use different power supply from that of the heat pump. Follow instructions by the manufacturer for how to wire the valves or flow meters.
- For any system not listed below, please contact us.

1. Example of multiple pump system

(load side: variable flow, heat pump side: variable flow)

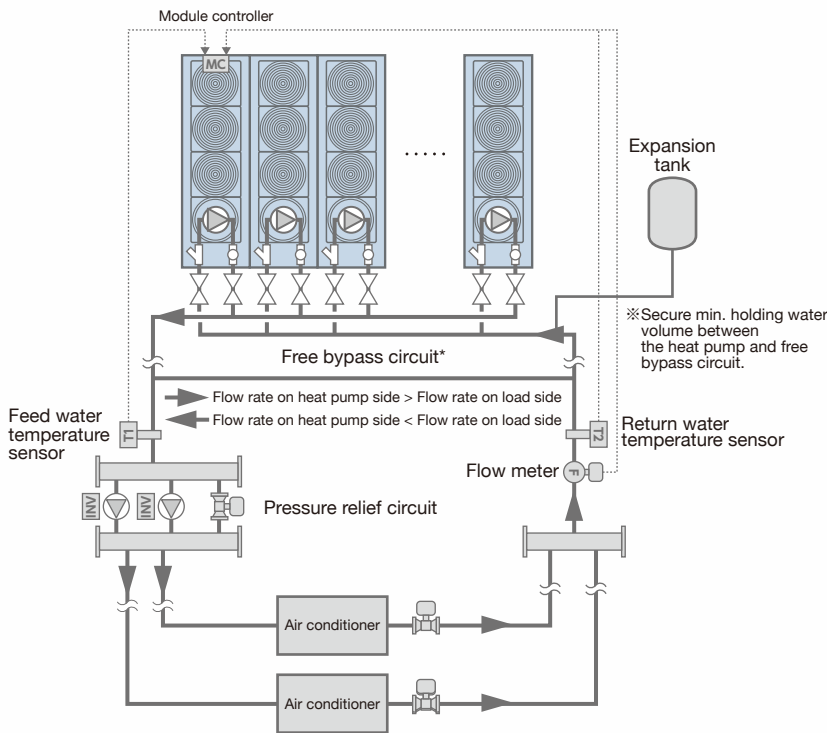

1. As there may be an unbalance in the load side pump flow rate and the heat pump flow rate, construct a normally open free bypass circuit.
2. LWT/EWT sensor in heat pump and water temperature sensor on feed/return water pipes detect the temperature balance inside system, and control the number of internal pump for cold/hot-water circulation and the frequency to minimize the unbalance between estimated load side flow rate and heat pump side flow rate. Mount the external sensors attached to the module controller on feedwater pipes and return water pipes, and connect the sensors to the module controller.
3. If there is a flow meter F (provided locally) in the system, connect its output to the module controller. This enables control which directly detects flow rate on the load side (mounting of external sensors on feed/return water pipes is required even when using a flow meter).
4. The module compressor which internal pump for cold/hot-water circulation controls the number of compressor and frequency so that the leaving water temperature approaches to the set temperature.

●List of equipment for control

Part name	Specification	Quantity	Provided locally	Constructed locally
Water temperature sensor (mandatory)	10kΩ external sensor	2	Attached to module controller	○
Flow meter	Able to measure instantaneous value Support voltage/current output*) (Able to adjust input range span: DC 0 to 5V)	1	○	○

*) Attach 250Ω±1% metal film resistor (provided locally) when the signal has current 4-20mA. (In that case, input range span is DC 1 to 5 V)

2. Single Pump Example of standard system

(load side: variable flow, heat pump side: variable flow)

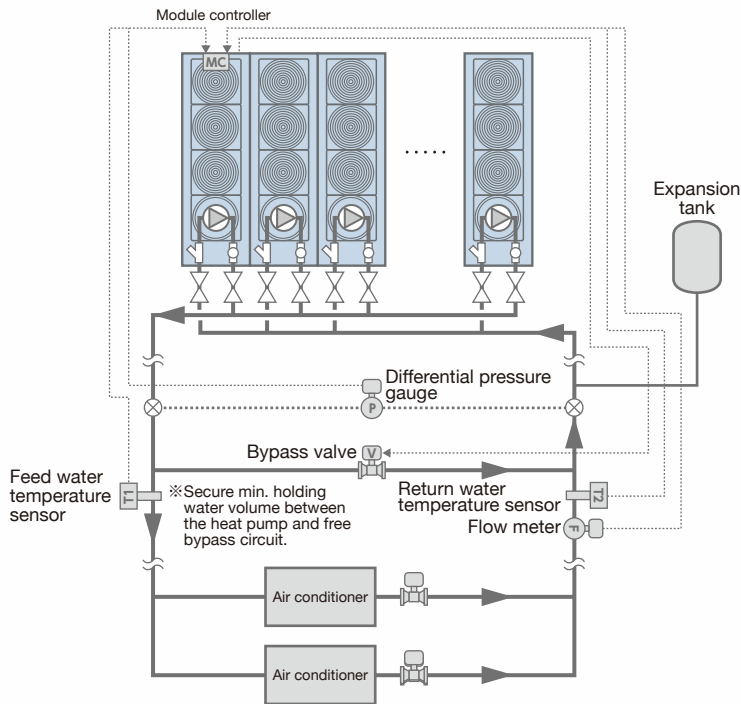

1. LWT/EWT sensor in heat pump and water temperature sensor on feed/return water pipes detect the temperature balance inside system, and control the number of internal pump for cold/hot-water circulation and the frequency to minimize the unbalance between estimated load side flow rate and heat pump side flow rate.
2. If there is a flow meter F (provided locally) in the system, connect its output to the module controller. This enables control which directly detects flow rate on the load side (mounting of external sensors on feed/return water pipes is required even when using a flow meter).
3. The module compressor which internal pump for cold/hot-water circulation controls the number of compressor and frequency so that the leaving water temperature approaches to the set temperature.
4. As there may be an unbalance in the load side required flow rate and the heat pump flow rate, construct a bypass valve V (provided locally) which is operated according to detection of differential pressure between feed/return water pipes. The bypass valve V is controlled by a module controller.
5. Even while the operation is stopped, freeze protection control may automatically operate the internal pump. The bypass valve may be forcibly opened to secure the flow path, and in this case water may not be supplied to equipment on load side (to feed water to the equipment on load side, be sure to open the 2-way valve on load side in accordance with freeze protection control of the heat pump, instead of configuring settings not to open the bypass valve.).

List of equipment for control

Part name	Specification	Quantity	Provided locally	Constructed locally
Water temperature sensor (mandatory)	10kΩ external sensor	2	Attached to module controller	○
Flow meter	Able to measure instantaneous value Support voltage/current output*) (Able to adjust input range span: DC 0 to 5V)	1	○	○
Differential pressure gauge (mandatory)	pressure gauge (mandatory) Able to measure instantaneous value Support voltage/current output*) (Able to adjust input range span: DC 0 to 5V)	1	○	○
Bypass valve (mandatory)	Globe valve which can perform proportional control at current input DC 4 to 20mA (Able to adjust span)	1	○	○

*) Attach 150Ω±1% metal film resistor (provided locally) when the signal has current 4-20mA. (In that case, input range span is DC 0.6 to 3 V)

3. Single Pump Example of other heat source dual-use system

(load side: variable flow, heat pump side:stepped variable flow (other heat pump: constant flow))

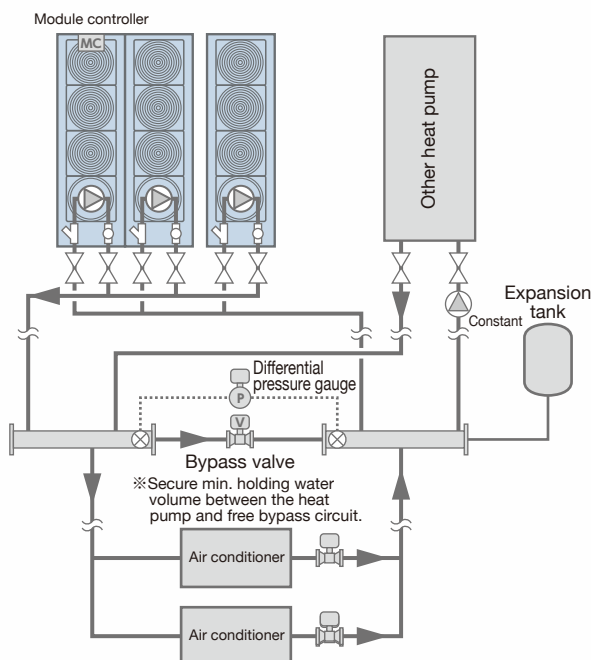

1. The internal pump for cold/hot-water circulation perform constant-control of the number of units (stepped variable flow) in accordance with the heat pump operation capacity.
2. The module compressor which internal pump for cold/hot-water circulation controls the number of compressor and frequency so that the leaving water temperature approaches to the set temperature.
3. As there may be an unbalance in the load side required flow rate and the heat pump flow rate, construct a bypass valve (provided locally) which is operated according to detection of differential pressure between feed/return water pipes.
4. Even while the operation is stopped, freeze protection control may automatically operate the internal pump. The bypass valve may be forcibly opened to secure the flow path to prevent, and in this case water may not be supplied to equipment on load side. (to feed water to the equipment on load side, be sure to open the 2-way valve on load side in accordance with freeze protection control of the internal chilled (warm) water circulation pump, instead of configuring settings not to open the bypass valve)

Group Controller

Batch control of heat source unit using the group controller

Up to eight sets, total 128 units, can be controlled at once from a single controller. Individual settings and operation states can be controlled and displayed via a touch panel, supporting customer energy management.

Function List

Item	Notes	
Operating status display	For each model	Start/Stop, Operational mode, Fault occurrence, Operational capacity, LWT/EWT, Flow rate, Simple production heat capacity, Basic integral power, Basic capabilities, Basic input, Basic COP
	For each module controller	Start/Stop, Operational mode, Error code, Operational capacity, LWT/EWT, Flow conversion volume, Basic capabilities, Basic input, Basic COP
	For each module	Start/Stop, Operational mode, Error code, Operational capacity, LWT/EWT, Flow conversion volume, Basic capabilities, Outside air temperature, Basic input, Basic COP
	For each circuit	Refrigeration cycle information, Compressor operation time, Compressor startup counts
Operational state output (Total)	Start/Stop, Failure, Operational capacity, Basic capabilities, Basic input, Operational pattern	
Start/Stop	For entire system, Each model, and Each module controller	
Pattern settings (Switch)	Enables setting and switching operating pattern of group controller	
Operational mode settings (Switch)	Enables setting and switching the operation mode for entire system.	
Preset temperature changes	All model temperature settings can be changed.	
Current demand settings	Electrical current demand can be configured.	
System settings	All connected modules can be systematically classified. (for each module controller system)	
Schedule settings	Operational schedule can be configured. (monthly, weekly, daily)	
Error history display	Error history can be verified.	
Operational data savings	Displayed data can be saved to MMC.	
Trend display	Water temperature, outside air temperature, operational capacity, basic capabilities, basic input, basic COP, basic production heat capacity, and basic integral power can be displayed on a graph.	
Power saving	Enables switching the demand setting to validation or invalidation.	

Example of System Configuration

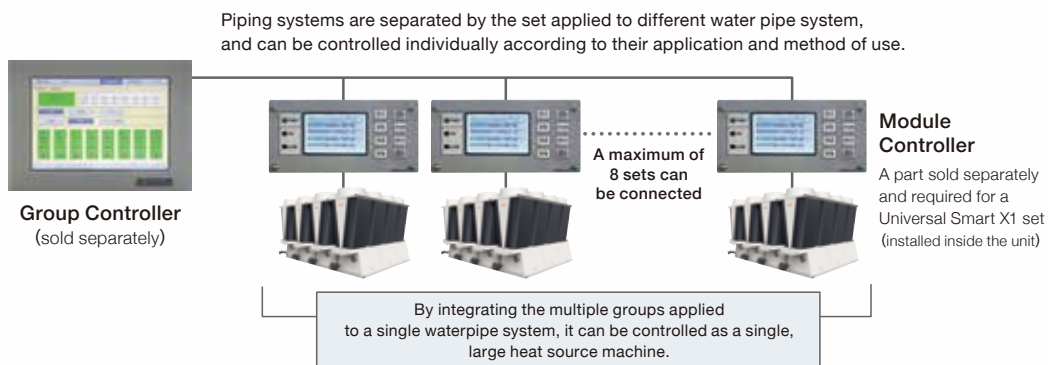

Example of a Screen Display



Operating Status/Main Screen

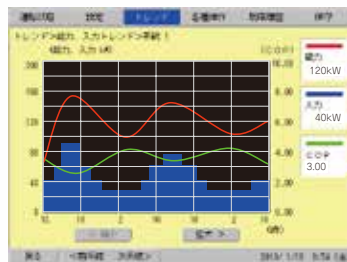

Operating Trends (capacity, input, COP) Confirmation Screen

By displaying the capacity/input (power consumption) over the past 48 hours, users can easily confirm the day-over-day effects of power conservation efforts, such as adjusting demand or the temperature settings. (time frame can be switched to the past 24 hours, 12 hours, and 6 hours)

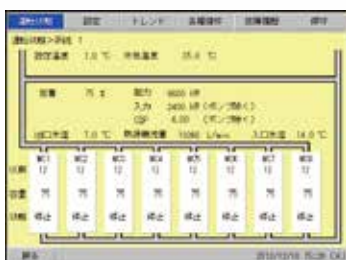

Operating Status/System Data Confirmation Screen

Demand Function

Users can set an upper limit of current (demand) using the Group Controller and peak shave.

Peak Shaving Scenario

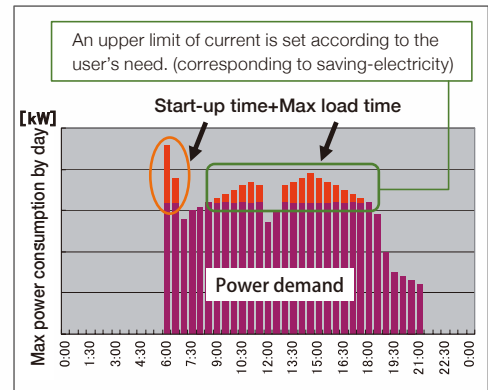

The upper limit of current (demand) can be set in units of 1 amp for each system.

Wifi Data Analysis

Wireless LAN-Equipped - Operating data can be obtained with tablet

The tablet improves the convenience of operation and management.
 Wireless LAN comes as standard in the module controller!
 Information can be collected without opening service panel.

- Confirm run time
- Confirm run pressure
- Confirm breakdown history



Supported tablets: Android 5.0 or higher 10.1" screen recommended

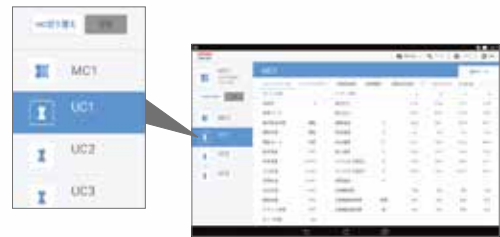

Visualized the operating status of module controller and unit controller!
It allows safe and quick operations even in bad weather!!

Option List

Item		Remarks	
		Factory assembly	Locally constructed
Related to products sold separately	Module controller (MC) <small>(Note 1) (Note 2)</small>	Required products sold separately	○ ×
	Group controller (GC)	Products sold separately	× ○ <small>(Note 3)</small>
	External sensor <small>(Note 2)</small> (two locations for temperature of outgoing and returning water)	Products sold separately	× ○ <small>(Note 3)</small>
	Connecting Bracket	Products sold separately	× ○ <small>(Note 3)</small>
	Protective screen kit	Products sold separately	○ ○ <small>(Note 3)</small>
	Flange kit for hood installation (for both intake and dischargesides)	Products sold separately	○ ×

- Note 1: Required to control multiple modules. It is installed in one of the modules.
 Note 2: Module controller with internal inverter pump contains external sensor (2 sensors for feed/return water temperature) for controlling one system of the water pipe systems. If an external sensor to control a secondary circuit of water pipes is required, an additional order must be placed. You also need to place an order for an external sensor for monitoring the temperature of return and condensation water for module controllers in pumpless models, which do not have external sensors.
 Note 3: On-site installation work is needed. (Not included in seller's work description.)
 Note 4: On-site support is not available after delivery of standard specification products.
 Note 5: Set according to pattern settings.

Item		Locally constructed and locally set up
Ext. temp setpoint input	MC and GC standard functions	Required
External capacity input	indent (MC)	Required <small>(Note 4)</small>
Maximum number of modules that can be operated input	indent (MC)	Required <small>(Note 4)</small>
Demand capacity input	indent (MC)	Required <small>(Note 4)</small>
Run/Stop input, make signal supported	MC and GC standard functions	Required
Run/Stop input, pulse signal supported (over 500 msec)	MC and GC standard functions	Required
Operation pattern input	MC and GC standard functions	Required
Enabling operation by each system input	MC standard functions	Required
Demand input	MC standard functions	Required
Pump interlock input	MC standard functions	Required
Forced fan operation input	indent (MC)	Required <small>(Note 4)</small>
Power outage recovery input	indent (MC・GC)	Required <small>(Note 4)</small>
Anti-freezing pump interlock input	indent (MC)	Required <small>(Note 4)</small>
Signal for mixed use of other heat pump inputs	indent (MC)	Required <small>(Note 4)</small>
Operation mode output (for each system)	indent (MC)	Required <small>(Note 4)</small>
Operating capacity output	MC and GC standard functions	Required
Simple input display (instant values)	GC standard functions	Not necessary
Simple watt-hour display (daily usage)	GC standard functions	Not necessary
Simple input/output (instant values)	GC standard functions	Required
Simple capacity display (instant values)	MC and GC standard functions	Not necessary
Simple heat production display (daily usage)	GC standard functions	Not necessary
Simple capacity output (instant values)	MC and GC standard functions	Required
Operation output (GC: Overall or by system)	MC and GC standard functions	Required
Malfunction output (GC: Overall or by system)	MC and GC standard functions	Required
Operation pattern output	MC and GC standard functions	Required
Operation mode output (cooling, heating, cooling/heating thermal storage)	MC standard functions	Required
Pump interlock output	MC standard functions	Required
Water spray device interlock output	MC standard functions	Required
Group output for peripheral devices (such as air conditioners)	indent (MC)	Required <small>(Note 4)</small>
Group output for defrosting	indent (MC)	Required <small>(Note 4)</small>
Output for freeze protection pump operation	indent (MC)	Required <small>(Note 4)</small>
Output at maximum-capacity operation	indent (MC)	Required <small>(Note 4)</small>
Scheduled operation function	GC standard functions	Required
Double setpoints (temperature setpoint) <small>(Note 5)</small>	MC standard functions	Required
Module operating time display	MC standard functions	Not necessary
Compressor run hours display	MC standard functions	Not necessary
Module startup counts display	MC standard functions	Not necessary
Compressor startup counts display	MC standard functions	Not necessary
Module operating time averaging control	MC standard functions	Not necessary
Compressor run hours averaging control	MC standard functions	Not necessary

Special Specifications Available

- **Brine specifications (can be used with ice thermal)**
 Support brine leaving temperature from -15°C to 4°C.
 Ice thermal is also supported.
- **High Temperature Difference Specifications**
 Support units with design LVG/ETG water temperature difference over 10°C and at or below 16°C
 (There is a limit to the settings of the leaving water temperature. Please make an individual inquiry regarding this.)
- **Corresponding to Chilled-water storage (fresh water)**
 Optimized energy-saving control to chilled-water storage.

Brine specifications

Can efficiently and precisely support various low-temperature processes with the brine specifications of the Universal Smart X EDGE series.

Brine-Spec Line-Up and Module Names

Model		With an inverter pump							
		Air-cooled cooling-only				Air-cooled heat pump			
60HP model	Standard type	RUA-UP511R1-S	RUA-UP511R2-S	RUA-UP511R3-S	RUA-UP511R4-S	RUA-UP511HR1-S	RUA-UP511HR2-S	RUA-UP511HR3-S	RUA-UP511HR4-S
	High-COP type	RUA-UP511NR1-S	RUA-UP511NR2-S	RUA-UP511NR3-S	RUA-UP511NR4-S	RUA-UP511HNR1-S	RUA-UP511HNR2-S	RUA-UP511HNR3-S	RUA-UP511HNR4-S
70HP model	Standard type	RUA-UP561R1-S	RUA-UP561R2-S	5RUA-UP561R3-S	RUA-UP561R4-S	RUA-UP561HR1-S	RUA-UP561HR2-S	RUA-UP561HR3-S	RUA-UP561HR4-S
	High-COP type	RUA-UP561NR1-S	RUA-UP561NR2-S	RUA-UP561NR3-S	RUA-UP561NR4-S	RUA-UP561HNR1-S	RUA-UP561HNR2-S	RUA-UP561HNR3-S	RUA-UP561HNR4-S

Model		Pumpless							
		Air-cooled cooling-only				Air-cooled heat pump			
60HP model	Standard type	RUA-UP511LR1-S	RUA-UP511LR2-S	RUA-UP511LR3-S	RUA-UP511LR4-S	RUA-UP511HLR1-S	RUA-UP511HLR2-S	RUA-UP511HLR3-S	RUA-UP511HLR4-S
	High-COP type	RUA-UP511LNR1-S	RUA-UP511LNR2-S	RUA-UP511LNR3-S	RUA-UP511LNR4-S	RUA-UP511HLNR1-S	RUA-UP511HLNR2-S	RUA-UP511HLNR3-S	RUA-UP511HLNR4-S
70HP model	Standard type	RUA-UP561LR1-S	RUA-UP561LR2-S	RUA-UP561LR3-S	RUA-UP561LR4-S	RUA-UP561HLR1-S	RUA-UP561HLR2-S	RUA-UP561HLR3-S	RUA-UP561HLR4-S
	High-COP type	RUA-UP561LNR1-S	RUA-UP561LNR2-S	RUA-UP561LNR3-S	RUA-UP561LNR4-S	RUA-UP561HLNR1-S	RUA-UP561HLNR2-S	RUA-UP561HLNR3-S	RUA-UP561HLNR4-S

● Brine leaving temperature and brine density

① Refer to the capacity table regarding the performance of the brine chiller. In addition, the density of the brine (ethylene glycol) is the density noted below so the freezing temperature is (brine outlet temperature) - (8°C).

Brine leaving temperature (°C)	°C	+5	0	-5	-10	-15
Ethylene glycol density (Nybrine Z1)	wt%	11 (15)	20 (27)	28 (38)	34 (46)	40 (54)
Propylene glycol density (Brine PFP)	wt%	12 (18)	22 (34)	29 (45)	35 (54)	40 (62)

② Commercially available ethylene glycol generally is a preservative added aqueous solution. Confirm the density of the base liquid when you purchase it, and then determine the required density according to the following example.
 [Example] If you are using Nybrine Z1 with a brine leaving temperature of -5°C, then given a base liquid that is 74.5% aqueous solution, then in Nybrine Z1 a 28 wt% density of ethylene glycol is $28 \text{ wt\%} \div 0.745 = 38 \text{ wt\%}$.

● Single Module unit Cooling Capacity Chart (for both internal inverter pump models and pumpless models)

Capacity Chart Standard type (60HP model)

Leaving cold-water temperature (°C)	Brine density (wt%)	Item	Outdoor air temperature (°C) (DB)				
			25	30	35	40	43
-15	40	Cooling capacity (kW)	82.0	78.1	73.8	69.3	66.5
		Nominal input (kW)	33.6	36.0	38.6	41.5	43.5
		Water flow rate (L/min)	273	260	246	231	221
		Nominal current (A)	51.6	55.3	59.5	63.7	66.9
-10	34	Cooling capacity (kW)	104	97.8	92.1	86.2	82.6
		Nominal input (kW)	36.6	39.4	42.6	46.1	48.0
		Water flow rate (L/min)	336	316	298	279	267
		Nominal current (A)	56.4	60.6	65.3	70.6	73.7
-7	30	Cooling capacity (kW)	120	112	105	98.3	94.2
		Nominal input (kW)	38.6	41.6	45.3	48.9	51.2
		Water flow rate (L/min)	382	356	334	313	299
		Nominal current (A)	59.5	63.7	69.5	75.3	78.5
-5	28	Cooling capacity (kW)	131	122	115	107	103
		Nominal input (kW)	39.9	43.1	46.9	50.7	53.1
		Water flow rate (L/min)	413	385	363	337	325
		Nominal current (A)	61.1	66.4	72.2	77.9	81.6
0	20	Cooling capacity (kW)	161	149	140	131	126
		Nominal input (kW)	43.1	46.7	51.1	55.5	58.3
		Water flow rate (L/min)	494	457	429	402	386
		Nominal current (A)	66.4	71.6	78.5	85.2	89.5

Note 1: Indicates when the leaving/entering cold-water temperature difference is 5°C.
 Note 2: Indicates performance when machine is run at rated frequency.

Note 3: Indicates when ethylene glycol is used.
 Note 4: In case the nominal current is 380V.

Standard type (70HP model)

Leaving cold-water temperature (°C)	Brine density (wt%)	Item	Outdoor air temperature (°C) (DB)				
			25	30	35	40	43
-15	40	Cooling capacity (kW)	90.6	86.2	81.4	76.3	73.2
		Nominal input (kW)	40.8	44.0	47.3	50.9	53.0
		Water flow rate (L/min)	302	287	271	254	244
		Nominal current (A)	62.7	67.4	72.7	77.9	81.6
-10	34	Cooling capacity (kW)	115	109	102	95.8	91.9
		Nominal input (kW)	44.8	48.2	52.3	56.4	58.9
		Water flow rate (L/min)	372	353	330	310	297
		Nominal current (A)	68.5	74.3	80.6	86.4	90.6
-7	30	Cooling capacity (kW)	133	125	117	110	105
		Nominal input (kW)	47.3	51.2	55.5	59.8	62.9
		Water flow rate (L/min)	423	397	372	350	334
		Nominal current (A)	72.7	78.5	85.3	91.6	96.4
-5	28	Cooling capacity (kW)	146	136	128	120	115
		Nominal input (kW)	49.2	53.1	57.7	62.5	65.3
		Water flow rate (L/min)	460	429	404	378	363
		Nominal current (A)	75.3	81.6	88.5	95.8	101
0	20	Cooling capacity (kW)	178	165	156	146	141
		Nominal input (kW)	53.6	57.9	63.2	68.5	71.9
		Water flow rate (L/min)	546	506	478	448	432
		Nominal current (A)	82.2	89.0	96.9	106	111

Note 1: Indicates when the leaving/entering cold-water temperature difference is 5°C.
 Note 2: Indicates performance when machine is run at rated frequency.

Note 3: Indicates when ethylene glycol is used.
 Note 4: In case the nominal current is 380V.

High-EER type (60HP model)

Leaving cold-water temperature (°C)	Brine density (wt%)	Item	Outdoor air temperature (°C) (DB)			
			30	35	40	43
-15	40	Cooling capacity (kW)	79.8	75.7	71.4	68.6
		Nominal input (kW)	32.4	35.1	37.8	39.7
		Water flow rate (L/min)	266	252	238	228
		Nominal current (A)	49.8	53.7	57.9	61.1
-10	34	Cooling capacity (kW)	102	96.3	90.6	87.1
		Nominal input (kW)	34.8	37.8	41.2	43.1
		Water flow rate (L/min)	330	311	293	282
		Nominal current (A)	53.7	57.9	63.2	66.4
-7	30	Cooling capacity (kW)	119	111	105	101
		Nominal input (kW)	36.3	39.5	43.0	45.3
		Water flow rate (L/min)	378	353	334	321
		Nominal current (A)	55.8	60.6	65.8	69.5
-5	28	Cooling capacity (kW)	132	122	115	111
		Nominal input (kW)	37.2	40.5	44.2	46.4
		Water flow rate (L/min)	416	385	363	350
		Nominal current (A)	56.9	62.2	67.9	71.1
0	20	Cooling capacity (kW)	165	152	143	137
		Nominal input (kW)	39.1	42.8	46.9	49.6
		Water flow rate (L/min)	506	466	439	420
		Nominal current (A)	60.0	65.8	72.2	76.4

Note 1: Indicates when the leaving/entering cold-water temperature difference is 5°C.
 Note 2: Indicates performance when machine is run at rated frequency.
 Note 3: Relative outside humidity of 40% and dispersing water supply temperature of 21°C.

Note 4: Indicates when ethylene glycol is used.
 Note 5: In case the nominal current is 380V.

High-EER type (70HP model)

Leaving cold-water temperature (°C)	Brine density (wt%)	Item	Outdoor air temperature (°C) (DB)			
			30	35	40	43
-15	40	Cooling capacity (kW)	89.4	84.9	80.0	76.9
		Nominal input (kW)	40.1	43.5	47.1	49.3
		Water flow rate (L/min)	298	283	266	256
		Nominal current (A)	61.6	66.9	72.2	75.8
-10	34	Cooling capacity (kW)	115	109	102	98.5
		Nominal input (kW)	43.2	47.0	51.0	53.5
		Water flow rate (L/min)	372	353	330	319
		Nominal current (A)	66.4	72.2	78.5	82.2
-7	30	Cooling capacity (kW)	135	126	119	114
		Nominal input (kW)	45.2	49.0	53.4	56.2
		Water flow rate (L/min)	429	401	378	362
		Nominal current (A)	69.5	75.3	82.2	86.4
-5	28	Cooling capacity (kW)	149	139	131	126
		Nominal input (kW)	46.4	50.6	55.0	58.1
		Water flow rate (L/min)	470	438	413	397
		Nominal current (A)	71.1	77.4	84.8	89.0
0	20	Cooling capacity (kW)	186	171	161	156
		Nominal input (kW)	49.6	53.8	58.8	62.2
		Water flow rate (L/min)	570	524	494	478
		Nominal current (A)	76.4	82.7	90.0	95.3

Note 1: When the leaving/entering cold-water temperature difference is 5°C.
 Note 2: Indicates performance when machine is run at rated frequency.
 Note 3: Relative outside humidity of 40% and dispersing water supply temperature of 21°C.

Note 4: Indicates when ethylene glycol is used.
 Note 5: In case the nominal current is 380V.

Brine Specifications

● Pump characteristics (Model with Internal inverter pump)

For reference, performance characteristic graph for models with internal pump shows values for a brine leaving temperature of -15°C, an ethylene glycol density of 40wt%, -8°C, and a propylene glycol density of 32wt%. Select a pump that can handle the required lift and flow rate.

Note 1: When brine leaving temperature is different or propylene glycol is used, the performance characteristics differ. Please contact to us.

Note 2: Please be aware that with an internal inverter pump for the brine specifications, the pump output set as standard differs from pure water specifications.

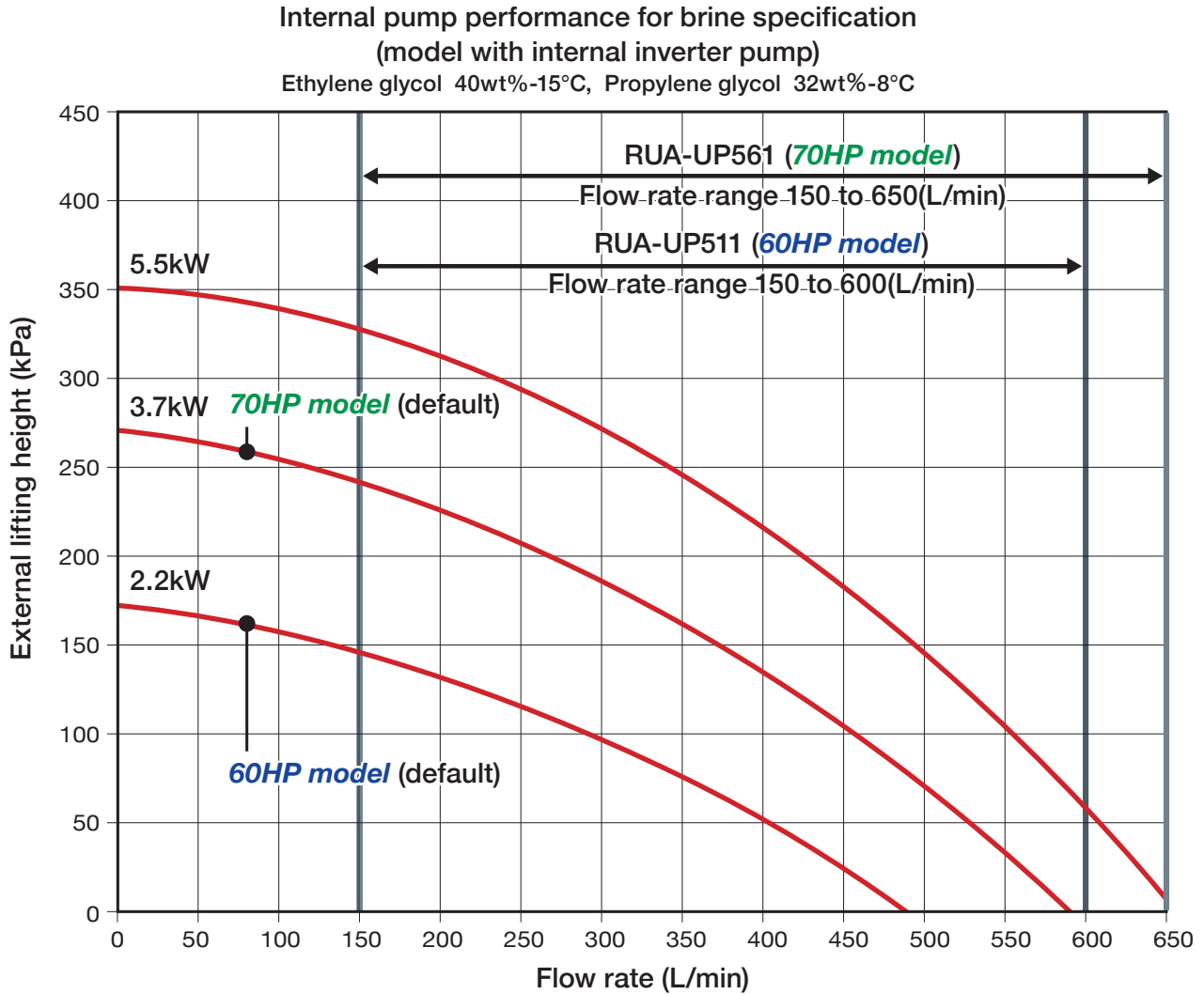

● Pump specifications

	(kW)	60HP model			70HP model	
		2.2	3.7	5.5	3.7	5.5
Pump output	(kW)	2.2	3.7	5.5	3.7	5.5
Flow rate range	(L/min)	150~490	150~590	150~600	150~591	150~650
External lifting height ^(*)2)	(kPa)	0 ⁽³⁵⁾ ~146	0 ⁽³⁵⁾ ~241	58~328	0 ⁽³⁵⁾ ~241	9~328
Max. operation current ⁽³⁾	(A)	4.6	7.4	11.4	7.4	11.4
Max. power consumption ⁽³⁾	(kW)	2.9	4.6	6.9	4.6	6.9
Max. allowable boost pressure	(MPa)	0.27	0.16	0.05	0.16	0.05
Max. suction head (water temp. 60°C or less)	(kPa)	40	40	40	40	40

Note 1: The flow amount range (upper limit), maximum current, and maximum consumption power on the graph are for one pump. Multiple by the number of pumps (modules) according to the size of the unit.

Note 2: The value for the pump lift outside the machine on the graph is when there is a pump frequency of 54Hz in the above flow amount range.

Note 3: The values indicated for maximum current and maximum consumption power are the highest values for when the pump operates at a frequency of 60Hz.

(In case the nominal current is 380V)

Note 4: Please use a 60Hz pump in common with other pumps in a 50Hz region.

Note 5: There are some ranges where the system cannot be flushed within the above flow amount range, and an increase in pump horsepower will be necessary.

Note 6: Should you use propylene glycol, the flow amount range may differ by density. Please make a separate inquiry regarding this.

● **Internal Pump Resistance (Pumpless model)**

(note) Please select a pump external to the heat source machine in consideration of the internal resistance indicated below for pumpless models.

**Internal resistance curve during brine use
(pumpless model, ethylene glycol)**

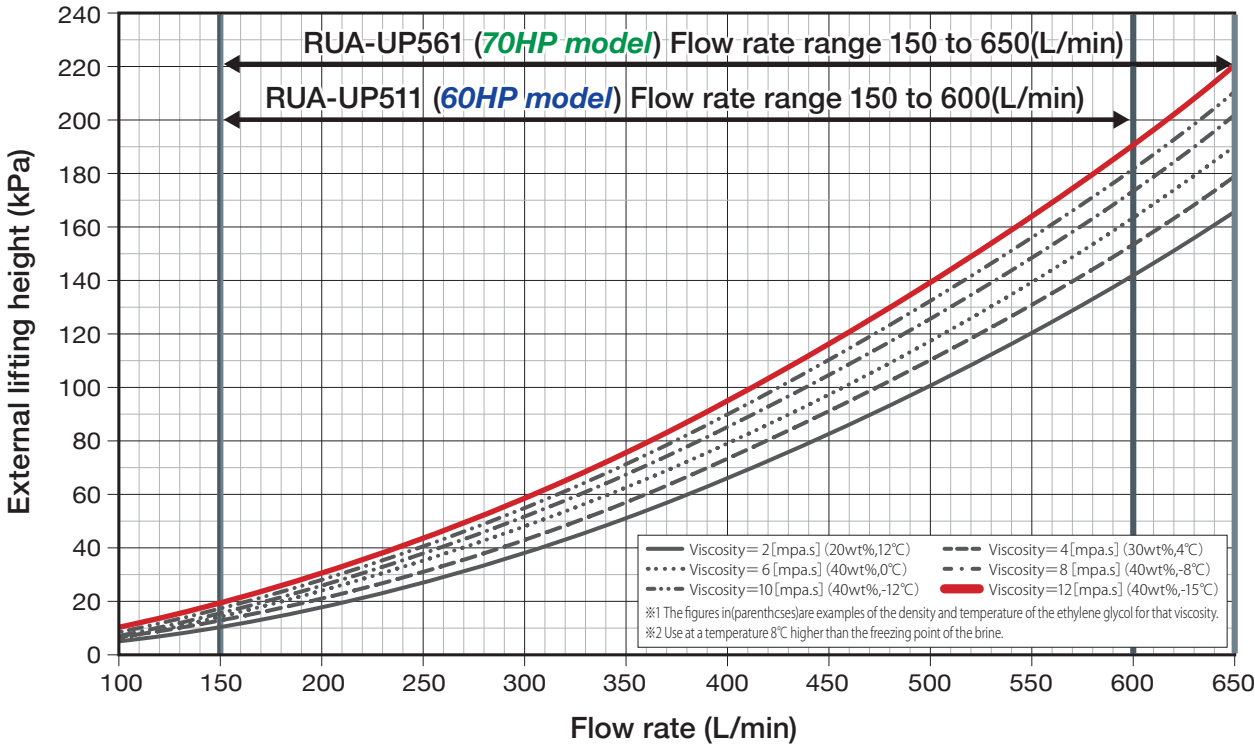

**Internal resistance curve during brine use
(pumpless model, propylene glycol)**

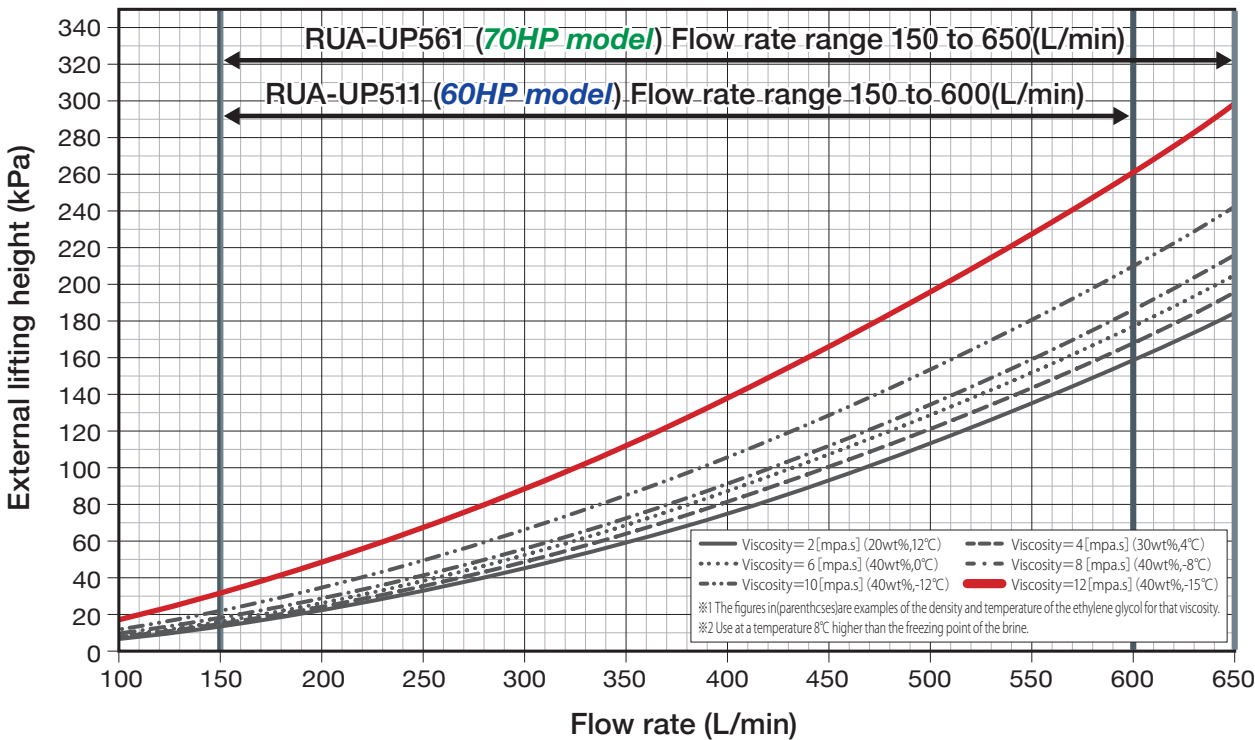

Installation and the use of refrigerants not specified by Toshiba Carrier Corporation

Toshiba refrigeration and air-conditioning units are designed and manufactured on the assumption that the product is used with a specific refrigerant suitable for each unit.

We have recently seen some cases where the type of refrigerant used is different from the one originally installed in the product.

Such actions may cause mechanical defects, malfunctions, failures and in some cases result in a serious safety issue. Therefore do not install any refrigerant other than the one specified by Toshiba Carrier Corporation for its respective products.

The type of the refrigerant used for each of our products is shown in the accompanying owners manual, or on the product label attached on the product itself.

Toshiba Carrier Corporation shall not assume any liability for failures, malfunctions or safety in its products if the refrigerant used is different from the one specified.



SAFETY PRECAUTIONS

Please see the Technical Document for details.

Notice : Toshiba is committed to continuously improving its products to ensure the highest quality and reliability standards, and to meet local regulations and market requirements. All features and specifications are subject to change without prior notice.
