



AQUAFORCE™

30XW Water-cooled Liquid Chiller With Total Heat Recovery

Cooling Capacity: 496~1549kW

Heating Capacity: 549~1718kW

Heat Recovery: 465~1654kW





In 1998, Time magazine named Dr. Carrier one of its 20 most influential builders and titans of the 20th century.

Carrier is a leading global provider of innovative HVAC, refrigeration, fire, security and building automation technologies. Supported by the iconic Carrier name, the company's portfolio includes industry-leading brands such as Carrier, Kidde, Edwards, LenelS2 and Automated Logic. Carrier's businesses enable modern life, delivering efficiency, safety, security, comfort, productivity and sustainability across a wide

range of residential, commercial and industrial applications.



Nomenclature

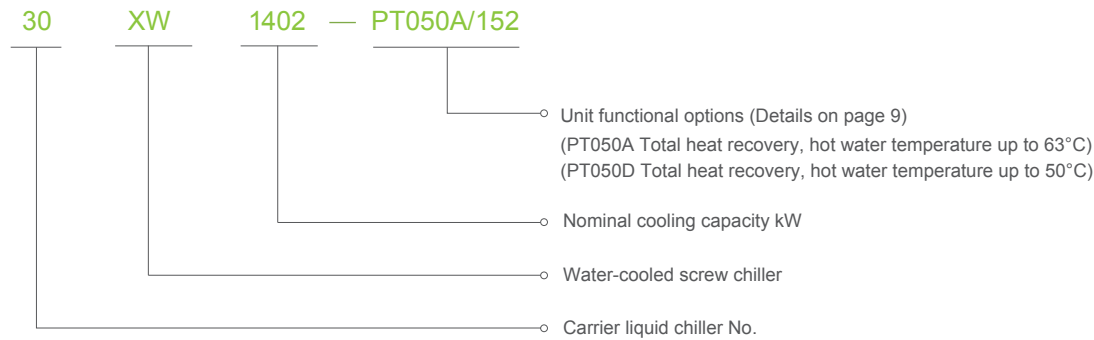

Operating range

Cooling / heating		
Evaporator temperature	Minimum	Maximum
Inlet water temperature at start-up	-	35°C
Outlet water temperature during operation	3.3°C	15/20°C **
Inlet/outlet temperature difference at full load	2.8°C	11.1°C
Condenser temperature	Minimum	Maximum
Inlet water temperature at start-up	13°C	-
Outlet water temperature during operation	19°C *	63°C
Inlet/outlet temperature difference at full load	2.8°C	11.1°C
Heat recovery temperature	Minimum	Maximum
Inlet water temperature at start-up	13°C	-
Outlet water temperature during operation	19°C *	63/50°C ***
Inlet/outlet temperature difference at full load	2.8°C	11.1°C

*If the temperature leaving the condenser is below 19°C, a water flow control valve must be used at the condenser (two or three-way valve). Please refer to option 152 to ensure the correct condensing temperature.

**PT050A is 15°C, PT050D is 20°C

***PT050A is 63°C, PT050D is 50°C

Cooling capacity: 496~1549 kW

Heating capacity: 549~1718 kW

Heat recovery: 465~1654 kW

Inheriting excellent quality of 30XW

Stewardship

- Non-ozone depleting refrigerant HFC-134a and no expired date.
- Excellent cooling performance and low energy consumption, reduce carbon dioxide emissions.

Leading technology and premium efficiency

- New 06T twin-screw compressor specifically designed for HFC-134a equipped with high efficiency motor and sliding valves with stepless regulation to precisely match capacity and building load changes.
- Patented line-design screw rotors increases compression efficiency.
- Motor directly driven compression rotor further enhances the efficiency of the compressor.
- Efficient semi-hermetical motor, refrigerant suction and cooling reduce power consumption.
- Flooded multi-pipe evaporator and condenser built-in spiral tube that enhance heat transfer efficiency both water and refrigerant side for energy consumption reduction.
- Electronic expansion device permits operation at a lower condensing pressure and improved utilization of the evaporator heat exchange surface.



Convenient installation

- Victaulic connections on the evaporator and condenser, simplified water connections in job-site.
- Standard configuration of electronic flow switch, simplified job-site installation.
- Unit is fully charged with refrigerant and lubricating oil, only water pipes and main power supply connection is required at job-site.

Total heat recovery applications, energy saving preferred

Traditional water-cooled unit

When the chiller is under cooling mode, the heat is transferred from the condenser and emitted into the atmosphere directly by cooling tower. It's a huge waste of heat energy for those requires heat, such as hotels, factories, hospitals, etc., and also bring some waste heat pollution to the surrounding environment. Besides, additional boiler is needed for hot water offering.

Carrier total heat recovery chiller

The total heat recovery chiller is designed by integrated condenser with two separated water loops, one is heating condenser and another is tower/geo-thermal-source condenser. It can take advantage of the vast amount of free heat energy 100% as the final or primary heat source for those applications of full-year hot water supply and boiler pre-heating. Thus, the wasted heat can be effectively utilized, increased system integrated efficiency. Also it can reduce or replace boiler capacity configured for domestic hot water or heating, and save the operating costs significantly.



Traditional water-cooled chiller and boiler

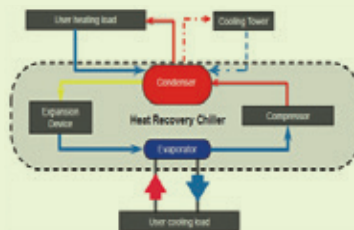

Total heat recovery applications

Safe and reliable

Water and electricity is cooperate the potential danger

Hot water and electricity in a chiller is completely separated for the safety of users and avoid the damage to equipment (such as electrical equipment) due to improper use.

Fuel is not used to prevent explosion

Total heat recovery chiller system does not use fuels (such as natural gas, etc.) due to operational oversight and eliminate explosions, fire, and other safety hazards.

Environmental-friendly

- ✔ **Recovery of condensate waste heat alleviate the “heat island effect”**
During cooling mode in summer, condensation waste heat discharged into the atmosphere is 100% recovered by the total heat recovery technology so as to alleviate the urban "heat island effect".
- ✔ **Replace the boiler heating to reduce smog and dust pollution**
Total heat recovery chiller technology uses clean air energy to offer air conditioning and hot water, which replaces the traditional direct-fired boiler and alleviate haze pollution caused by coal burning oil.
- ✔ **Geothermal energy with low noisy and sterility**
During heat recovery of the heat pumps, cooling towers is not required so as to avoid fan noise and mold contamination of cooling tower, and it can keep clean and beautiful environment through using geothermal energy.

Good lifecycle cost

- ✔ **Boiler is omitted so as to save investment**
Saves initial investment and annual inspection costs of boiler system, as well as costs of boiler room design and construction.
- ✔ **Free hot water reclaim with high integrated efficiency**
Due to waste heat recovery, hot water can be made freely in summer, which can dramatically reduce energy consumption and the combined cooling and heating COP can reach up to 9.

Intelligent control

- ✔ **Carrier SmartView® Control System**
New innovative Carrier SmartView® control system combines intelligence with operating simplicity which providing more comfortable operation experience. The control constantly monitors all machine parameters and precisely manages the operation of compressors, electronic expansion devices and of the evaporator water pump for optimum energy efficiency. Carrier SmartView® control panel supports CCN, BACnet IP, Modbus TCP/IP and Modbus RTU protocols, with which chiller can seamlessly connect with the Building Automation System or the i-Vu™/WebCTRL control network. Moreover, LonWorks, J-Bus and BACnet MSTP is also supported with optional gateway.
- ✔ **Intelligent control can balance cooling, heating and hot water supply adaptively**
Due to adaptive function, the total heat recovery can balance cooling, heating and hot water supply automatically to meet multiple needs of air-conditioning and hot water based on user requirements.

Space-saving

- ✔ **Multifunction applications replace boiler for space-saving**
Heat pump with total heat recovery function is integrated with cooling, heating and hot water supply, providing year-round hot water solutions. Users do not need to add boilers or other hot water equipments, and space-saving is achieved as a result, which substantially increases the utilization of architectural space and facilitate to increase future investment value.
- ✔ **Compact structure**
Compact design with a width of approximately 1.3 m, the chiller can pass through standard door openings and only require minimum floor space in the plant room due to small footprint.

completely separated to eliminate the power of total heat recovery to guarantee the personal safety (no threat of electric shock due to electric boilers) insulation aging or prevent blasting accidents. The systems do not use flammable refrigerants (kerosene, etc.), to avoid leaks and prevent of disrepair for many years. The systems are safe and other accidents.

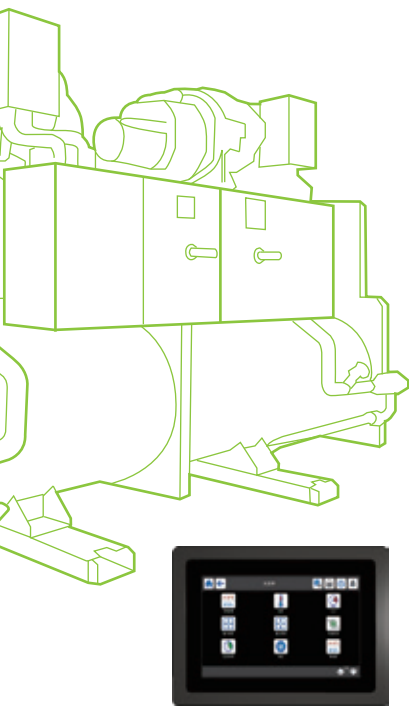

System application

Five operating modes

30XW total heat recovery chiller has five operating modes, it can meet hot water needs according to different season and vertical applications



Annual hot water solution
Water temperature up to 63 °C



Cooling mode(Recommend to operate in cooling season, i.e. summer)
Cooling with heat recovery system meets the indoor comfort requirements

Cooling and heat recovery mode, (Recommend to operate in cooling season, i.e. summer)
Meet cooling demands, while recovering condensation waste heat for free hot water

Heat recovery mode(Recommend full-year operation)

Heating mode (Recommend to operate in heating season, i.e. winter)
Water source heat pump with heat recovery system meets the indoor comfort requirements

Heating and heat recovery mode, (Recommend to operate in heating season, i.e. winter)
Using time-sharing control technology, it can meet the indoor heating as well as hot water requirements

Cooling with total heat recovery application

30XW cooling with heat recovery applications

This application has 3 operating modes, including cooling only, heat recovery cooling and heat recovery, except meet the conventional cooling requirements, it can also offer sanitary hot water freely, users only need to connect the heat recovery chiller, hot water tank, cooling tower, water pumps, pipe connections and valves, and cooling season application such as summer is recommended. When heat recovery is required, cooling tower water pump is closed, and all condensed heat is recovered by heating condenser, the hot water is total freely, and the chilled water is supplied at the same time as usual so as to achieve simultaneous applications of heating and cooling, enhance the integrated system efficiency, and the system can auto-detect whether it is necessary to switch to cooling tower mode based hot water set temperature

Cooling and heat recovery modes can set different priority levels based on actual needs so as to meet different customer requirements.

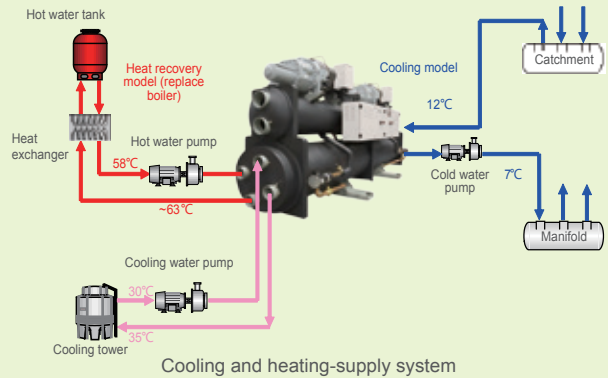

Notes: the above schematic is supplied for reference, please refer the product drawings for water connection.

Heat pump with total heat recovery application

30XW heat pump with total heat recovery application

This application has five operating modes, which are cooling, heat recovery, cooling and heat recovery, heating, heating and heat recovery. The chiller can take advantage of a variety of low order heat source, such as water/ground source, river, lake and sea water, in addition to achieve cooling in summer and heating in winter, it can also provide users with a worry-free year-round hot water solutions, and truly reflect a multi-purpose function.

Driven by electric energy, heat pump recovery chiller extracts free energy from low order heat sources. As the temperature of the earth's surface has the characteristics of warm in winter and cool in summer, normally, the input power of 1kW can obtain more than 5kW cooling capacity or more than 4kW heating capacity, and the efficiency is much higher than heating and cooling forms of other central air conditioning. It saves about 30% energy consumption compared with the conventional air-source heat pumps system, and about 70% of energy consumption compared with electric heating modes. Combined with the integrated hot water applications, it saves expensive boiler system, and the system is more energy efficient.

a. Heat pump with heat recovery application in summer
The system has cooling and cooling plus heat recovery functions.

When heat recovery is required, the ground source side pump is closed and hot water pump is turn on to offering hot water freely. Cooling and heat recovery modes can set different priority levels based on actual needs so as to meet different customer requirements.

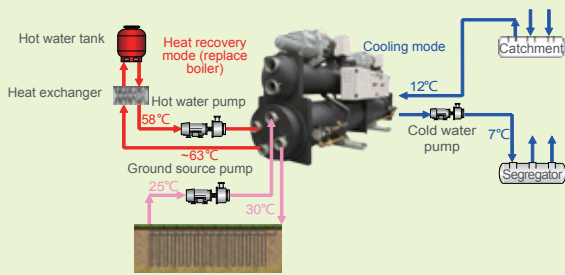

Cooling and heating-supply system

b. Heat pump with heat recovery application in winter and transitional seasons
The system has heating and hot water, heating plus heat recovery functions. It also can set different priority levels of heating and heat recovery based on actual needs.

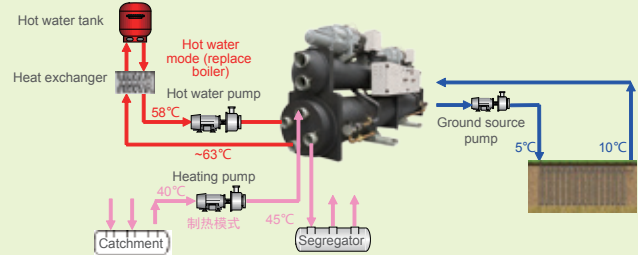

Heating and hot water-supply system

Notes: the above schematic is supplied for reference, please refer the product drawings for water connection.

Economic Analysis

Take a hotel for example. The hotel can accommodate 300 people, has requirements of cooling, heating and hot water, cooling load is 650kW in summer, heating load is 450kW in winter, daily hot water is amount 150 liters per people, so the daily consumption of hot water is 45 tons, sanitary water is heated from 10 C to 50 C, and designed heat consumption per hour is 330 kW. The annual operation costs comparisons of different hot water and air-conditioning equipment are as followings. Compared with "air-cooled heat pumps + boiler" and "water-cooled chiller + boiler" solutions, annual operating cost of water source heat pumps with total heat recovery can save 40% and 50% respectively; and annual hot water costs reduce 65%.

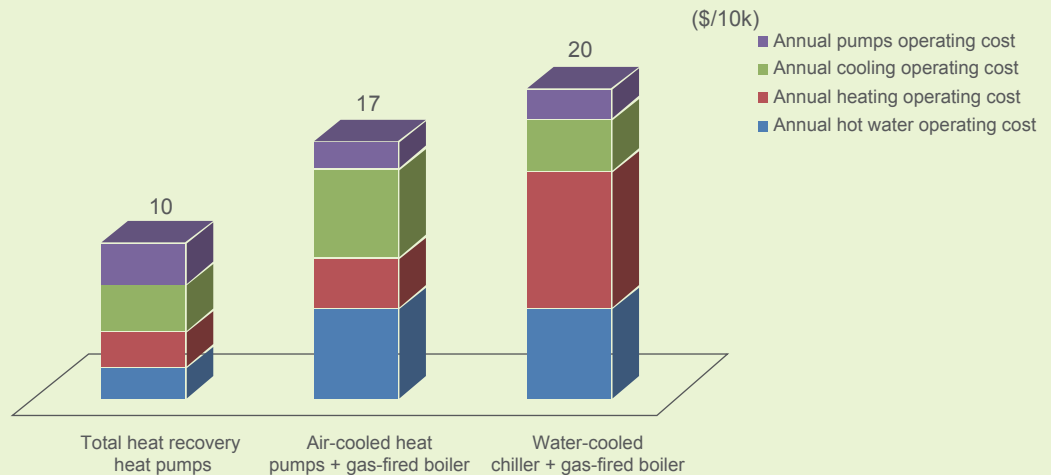

Seawater-source total heat recovery heat pump system application

Due to corrosiveness of seawater, as special full heat recovery heat pump system of surface water, higher demand is required by seawater-source heat pump system.

For the open-seawater heat exchange system, seawater enters directly into the heat exchanger of the heat pump unit, and therefore the unit must be equipped copper-nickel alloy pipe with corrosion resistance of Carrier, while the inner wall of the heat exchanger which is in direct contact with the water needs to be embalmed.

Performance data (heat recovery temperature up to 50°C and 63°C)

Model		30XW-PT050D (50 °C)							30XW-PT050A (63 °C)							
		0502	0702	0902	1052	1262	1402	1602	0502	0702	0902	1052	1262	1402	1602	
Cooling performance																
Cooling capacity	kW	496	698	842	1033	1195	1382	1549	499	700	849	1040	1207	1392	1534	
Input power	kW	92	123	148	183	205	237	286	100	140	170	204	238	275	307	
Evaporator	Water flow rate	L/s	24	33	40	49	57	66	74	24	33	40	50	58	66	73
	Water pressure drop	kPa	69	62	84	115	78	91	81	68	60	83	112	77	89	80
Condenser	Water flow rate	L/s	26	35	45	53	60	70	80	23	32	44	47	55	63	72
	Water pressure drop	kPa	89	104	85	54	66	86	107	88	101	85	53	65	85	106
Heating performance																
Heating capacity	kW	555	769	971	1147	1313	1512	1718	549	770	977	1140	1323	1525	1687	
Input power	kW	120	161	196	237	267	308	370	116	162	203	236	275	318	353	
Evaporator	Water flow rate	L/s	21	29	37	44	50	58	65	21	30	38	44	51	59	65
	Water pressure drop	kPa	55	48	73	92	62	71	64	55	48	73	91	62	71	65
Condenser	Water flow rate	L/s	27	37	47	55	63	73	83	26	37	47	55	64	74	81
	Water pressure drop	kPa	78	89	79	46	57	74	92	74	85	77	44	55	71	89
Heat recovery performance																
Heat recovery capacity	kW	530	728	941	1097	1248	1440	1654	465	652	915	974	1129	1303	1474	
Input power	kW	135	181	223	268	297	348	422	150	215	283	311	362	420	488	
Heat recoverer	Water flow rate	L/s	26	35	45	53	60	70	80	23	32	44	47	55	63	72
	Water pressure drop	kPa	74	90	58	39	47	60	72	55	67	50	29	36	46	56
Compressor																
Circuit A	n	1	1	1	1	1	1	1	1	1	1	1	1	1	1	1
Circuit B	n	-	-	-	1	1	1	1	-	-	-	1	1	1	1	
Minimum capacity	%	15	15	15	8	8	8	8	30	15	15	15	8	8	8	
HFC-134a refrigerant charge																
Circuit A	kg	135	150	150	90	140	140	160	135	150	150	90	140	140	160	
Circuit B	kg	-	-	-	90	130	130	140	-	-	-	90	130	130	140	
Water connection																
Evaporator connection	DN	125	150	150	150	200	200	200	125	150	150	150	200	200	200	
Condenser connection	DN	100	100	150	150	150	150	150	100	100	150	150	150	150	150	
Heat recovery connection	DN	100	100	150	150	150	150	150	100	100	150	150	150	150	150	
Dimension																
Length	mm	3363	3454	3274	4888	4891	4891	4891	3363	3454	3274	4888	4891	4891	4891	
Width	mm	1085	1119	1258	1338	1338	1338	1338	1085	1119	1258	1338	1338	1338	1338	
Height	mm	1791	1969	2094	2187	2358	2358	2459	1791	1969	2094	2187	2358	2358	2459	
Shipping weight	kg	3918	4792	5408	9274	10239	10507	10624	3932	4916	5535	9302	10374	10755	10878	
Operation weight	kg	3543	4402	5008	8464	9409	9677	9794	3557	4526	5135	8492	9544	9925	10048	

- Notes: 1. Cooling condition: Evaporator entering and leaving temperature is 12/7°C, Condenser entering and leaving temperature is 30/35°C, Fouling factor is 0.018/0.044m².°C/kW
2. Heating condition: Evaporator entering and leaving temperature is 12/7°C, Condenser entering and leaving temperature is 40/45°C, Fouling factor is 0.018/0.044m².°C/kW
3. Heat recovery condition (PT050D): Evaporator entering and leaving temperature is -7°C, water flow rate is equal to above evaporator under cooling condition; Condenser entering and leaving temperature is 45/50°C, Fouling factor is 0.018/0.044m².°C/kW
4. Heat recovery condition (PT050A): Evaporator entering and leaving temperature is -7°C, water flow rate is equal to above evaporator under cooling condition; Condenser entering and leaving temperature is 58/63°C, Fouling factor is 0.018/0.044m².°C/kW
5. Chiller heat exchanger is two passes design and standard pressure in water-side is 1.0MPa; Condenser and heat recovery two separated water loops are designed in the intergrated heat exchanger

Electrical parameters 30XW total heat recovery

30XW total heat recovery	30XW-PT050D (50 °C)								30XW-PT050A (63 °C)								
		0502	0702	0902	1052	1262	1402	1602	0502	0702	0902	1062	1262	1402	1602		
Power circuit																	
Rated Voltage	V-ph-Hz	400-3-50								400-3-50							
Voltage Range	V	360-440								360-440							
Control circuit		24 V per internal transformateur								24 V per internal transformateur							
Nominal start-up current*																	
Circuit A	A	414	587	587	450	587	587	587	587	772	772	587	772	772	772		
Circuit B	A	-	-	-	450	587	587	587	-	-	-	587	587	772	772		
Option 81	A	-	-	-	612	749	801	819	-	-	-	757	943	1015	1028		
Maximum start-up current **																	
Circuit A	A	414	587	587	450	587	587	587	587	772	772	587	772	772	772		
Circuit B	A	-	-	-	450	587	587	587	-	-	-	587	587	772	772		
Option 81	A	-	-	-	692	829	904	938	-	-	-	887	1072	1202	1232		
Cosine Phi																	
Nominal ***		0.87	0.89	0.90	0.87	0.88	0.88	0.90	0.85	0.86	0.87	0.85	0.86	0.86	0.87		
Maximum †		0.90	0.91	0.92	0.90	0.90	0.90	0.92	0.91	0.90	0.90	0.91	0.91	0.91	0.91		
Maximum power draw ††																	
Circuit A	kW	151	200	233	151	184	200	223	191	268	286	191	252	271	290		
Circuit B	kW	-	-	-	151	151	184	223	-	-	-	191	252	252	290		
Option 81	kW	-	-	-	302	355	384	446	-	-	-	382	443	523	580		
Nominal current draw ***																	
Circuit A	A	162	214	232	162	193	214	232	171	243	256	171	229	243	256		
Circuit B	A	-	-	-	162	162	193	232	-	-	-	171	171	229	256		
Option 81	A	-	-	-	324	355	407	464	-	-	-	342	400	472	512		
Maximum current draw (Un) ††																	
Circuit A	A	242	317	351	242	295	317	351	300	430	460	300	400	430	460		
Circuit B	A	-	-	-	242	242	295	351	-	-	-	300	400	400	460		
Option 81	A	-	-	-	484	537	612	702	-	-	-	600	700	830	920		
Maximum current draw (Un -10%) †																	
Circuit A	A	260	340	358	260	304	340	358	330	455	476	330	419	455	476		
Circuit B	A	-	-	-	260	360	340	358	-	-	-	330	330	419	476		
Option 81	A	-	-	-	484	564	644	716	-	-	-	660	749	874	952		

* Instantaneous start -up current (locked rotor current of the largest compressor + the rated load current of other smaller motors at nominal operating conditions)

Values obtained at operating condition: evaporator temperature entry/leave water = 12°C/7°C, condenser temperature entry/leavewater = 30°C/35°C

** Instantaneous start -up current (locked rotor current of the largest compressor + the maximum load current of other smaller motors at maximum unit conditions)

values obtained at operation with maximum unit power input

*** Values obtained at operating condition: evaporator temperature entry/leave water = 12°C/7°C, condenser temperature entry/leavewater = 30°C/35°C

† Values obtained at operation with maximum unit power input

†† Values obtained at operation with maximum unit power input Values given on the name plate

Options & accessories

Options	NO	Description	Advantages	Use
IP44 Enclosure	20	IP44 Enclosure(Control box & Terminal box)	Higher water & rust protection level for control box & terminal box	30XW0502~1602PT050A /PT050D
Soft starter	25	Provide unit soft starting, uninterrupted changeover without current peak that would stress power supply * Using a soft starter instead of Wye-Delta starter	Lower peak start-up current	30XW0502~1602PT050A /PT050D
Heat recovery Max condenser leaving (temp 63 C)	050A	Heat pump control logic to control condenser LWT * Use of air-cooled unit compressors * Increase size of electrical componts according to compressor motor electrical characteristics * Heat pump control logic * Condenser insulation	Allows heating applications with max condenser leaving temp 63 C	30XW0502~1602PT050A
Heat recovery (Max condenser leaving temp 50 C)	050D	Heat pump control logic to control condenser LWT * Increase size of electrical componts according to compressor motor electrical characteristics * Heat pump control logic * Condenser insulation	Allows heating applications with max condenser leaving temp 50 C	30XW0502~1602PT050D
Single power connection	81	This option is required to allow to connect on single powersupply line to one single location where std machine require two	Quick and easy installation	30XW1052~1602PT050A /PT050D
Evaporator &Condenser waterpresue 1.6MPa	104	Reinforced evaporator & condenser for extension of the maximum water-side service pressure to 1.6MPa	Covers applications with a high water column (high buildings)	30XW0502~1602PT050A /PT050D
Evaporator with reversed water connection	107E	Evaporator with reversed water inlet/outlet	Simplification of the water piping	30XW0502~1602PT050A /PT050D
CCN to J bus gateway	148B	Two way protocol converter board between CCN and J-Bus for easy connection to BMS. Consist of: - Electronic board mounted in the unit electrical cabinet - Automatic configuration at start up	Easy connection by communication bus to a building management system	30XW0502~1602PT050A /PT050D
CCN to BAC Net/Modbus gateway	148C	Two way protocol converter board between CCN and BAC Net/ Modbus for easy connection to BMS. Consist of: - Electronic board mounted in the unit electrical cabinet - Automatic configuration at start up	Easy connection by communication bus to a building management system	30XW0502~1602PT050A /PT050D
CCN to Lon work gateway	148D	Two way protocol converter board between CCN and Lon walk for easy connection to BMS. Consist of: - Electronic board mounted in the unit electrical cabinet - Automatic configuration at start up	Easy connection by communication bus to a building management system	30XW0502~1602PT050A /PT050D
CCN to BACNet-IP gateway	149	Two way protocol converter board between CCN and BAC Net-ip for easy connection to BMS. Consist of: - Electronic board mounted in the unit electrical cabinet - Automatic configuration at start up	Easy connection by communicationbus to a building management system	30XW0502~1602PT050A /PT050D
Condenser water valve control (0-10V signal)	152	Output signal (0-10V) to control the condenser water inlet valve Consist of: - One 8DO+4AI/2AO Board - Connector for 3 way valve Note: Power supply for water valve is not included	Used for applications with cold water at the condenser inlet (well water). In this case the valve controls the water entering temperature to maintain an acceptable condensing pressure	30XW0502~1602PT050A /PT050D
Energy management module	156	Remote control module. Additional contacts for an extension of the unit control functions (without communication bus) Consist of: - Electrinoc board mounted in the unit electrical cabniet	Easy connection by wired connection to a building management system	30XW0502~1602PT050A /PT050D
Evaporator flanged connections	314E	Victaulic to Flange water connections	Easy installation	30XW0502~1602PT050A /PT050D
Condenser flanged connections	314C	Victaulic to Flange water connections	Easy installation	30XW0502~1602PT050A /PT050D
Nitrogen charge	320	Unit nitrogen factory charged.	Less weight. No refrigerant charged	30XW0502~1602PT050A /PT050D
Discharge shut off valve	321	Allows referigerant to be stored inside the chiller during servicing	Reducing refrigerant loss and eliminating time-consuming transfer procedures	30XW0502~1602PT050A /PT050D
Low noise	257	Provide 2 to 4 dBA sound attenuation vs std to meet low noise application * Innovative lagging used	Lower operating sound levels	30XW0502~1602PT050A /PT050D
Terminal box condensation free	322	Recommended for tropical environments (hot and humid). Consist of: -Slope bottom of terminal box. -A water drain tube from the bottom of terminal box. -Thermal insulation on the surface of terminal box.	Avoid the condensation appearing on the surface of terminal box and accumulating internally. Also prevent condensation dropping on the control box where bellow the terminal box.	30XW0502~1602PT050A /PT050D

Coding instructions:

When multiple options coexist, the larger number is row on the right, and the options are separated by "/", for example:30XW1402 total heat recovery unit configures single power connection and cooling water valve control, its unit model is: 30XW1402-PT050A / 081/152

Notes:

1. IP44 enclosure PT020 is not compatible with PT025/PT258/PT322
2. Condenser water valve control option is not include 3 way valve and power supply for water valve

Dimensions drawing

30XW0502-0902PT050A/PT050D

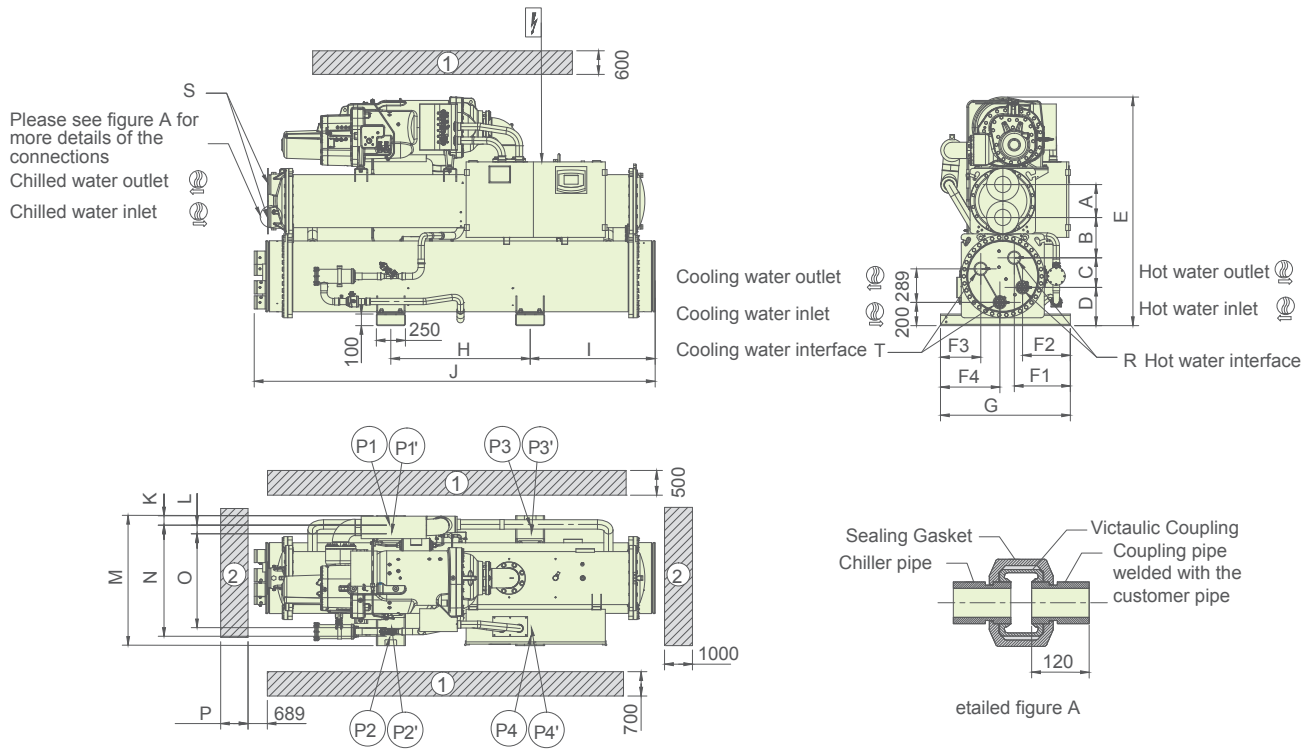

Note :

- ① Required clearance for maintenance, ② Recommended space for tube removal
- Pi and Pi' are two groups of bolts to fix the chiller, either group can be selected
- The water pipe connector is Victaulic coupling, the Victaulic and the pipe are supplied with the chiller, the pipe length is 120mm

Model (mm)	A	B	C	D	E	F1	F2	F3	F4	G	H	I	J	K	L	M	N	O	P	S	R	T
30XW0502PT050A/D	272	307	264	286	1791	458	399	380	475	1085	1600	832	3363	25	75	1085	1035	885	3160	DN125	DN100	DN100
30XW0702PT050A/D	284	346	255	330	1969	482	412	347	512	1119	1200	1077	3454	80	75	1119	958	808	3160	DN150	DN100	DN100
30XW0902PT050A/D	284	337	340	398	2094	625	525	305	465	1258	1500	827	3274	40	100	1258	1178	978	3160	DN150	DN150	DN150

Model (kg)	P1	P2	P3	P4	P1'	P2'	P3'	P4'	PT
30XW0502PT050D	1068	1325	513	637	1041	1351	501	651	3543
30XW0502PT050A	1071	1328	517	641	1044	1354	504	654	3557
30XW0702PT050D	1140	1718	613	931	1074	1784	577	968	4402
30XW0702PT050A	1171	1749	644	962	1105	1815	608	999	4526
30XW0902PT050D	1627	1500	981	901	1641	1485	990	892	5008
30XW0902PT050A	1657	1532	1013	933	1672	1516	1022	924	5135

Dimensions drawing

30XW1052-1602PT050A/PT050D

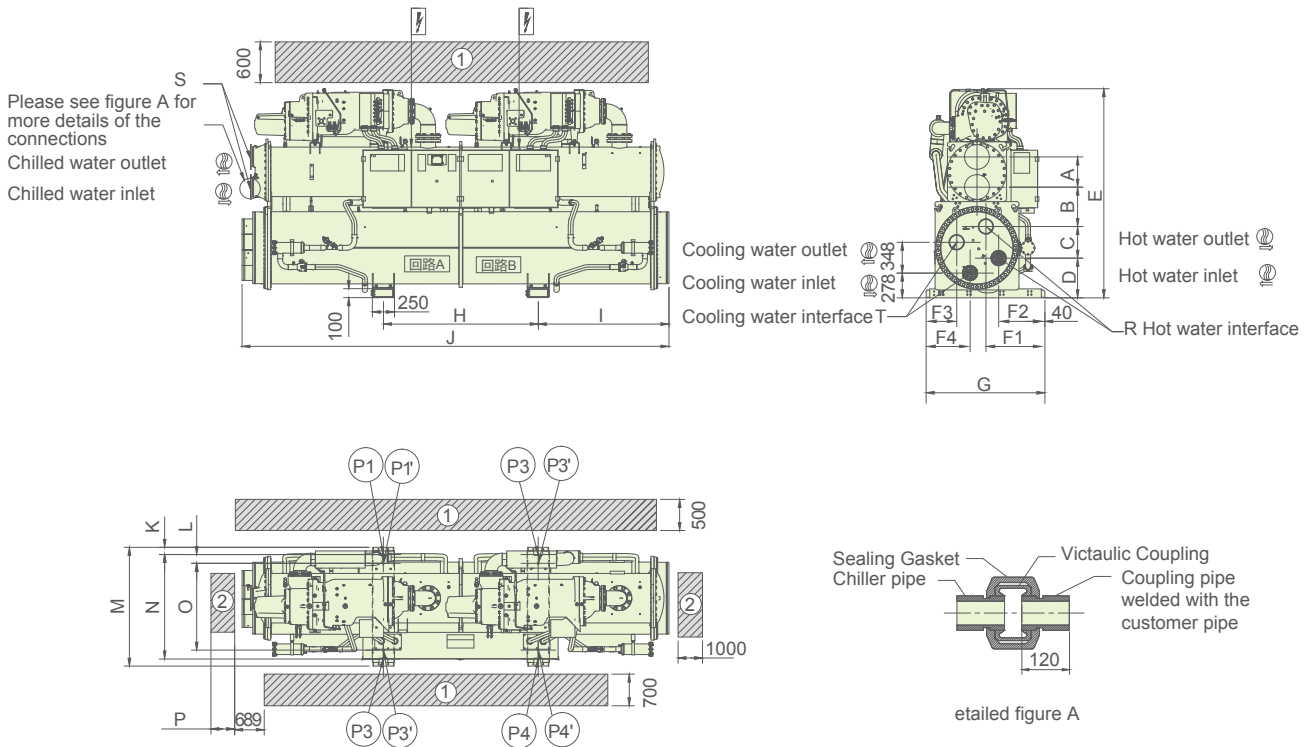

Note :

- ① Required clearance for maintenance, ② Recommended space for tube removal
- Pi and Pi' are two groups of bolts to fix the chiller, either group can be selected.
- The water pipe connector is Victaulic coupling, the Victaulic and the pipe are supplied with the chiller, the pipe length is 120mm

Model	A	B	C	D	E	F1	F2	F3	F4	G	H	I	J	K	L	M	N	O	P	S	R	T
30XW1052PT050A/D	284	422	356	447	2187	665	520	345	495	1338	1745	1521	4888	80	100	1338	1178	978	4550	DN150	DN150	DN150
30XW1262PT050A/D	340	445	356	447	2358	625	480	305	455	1338	1745	1522	4891	80	100	1338	1178	978	4550	DN200	DN150	DN150
30XW1402PT050A/D	340	445	356	447	2358	625	480	305	455	1338	1745	1522	4891	80	100	1338	1178	978	4550	DN200	DN150	DN150
30XW1602PT050A/D	340	531	356	447	2459	665	520	345	495	1338	1745	1524	4891	80	100	1338	1178	978	4554	DN200	DN150	DN150

Model	P1	P2	P3	P4	P1'	P2'	P3'	P4'	PT
30XW1052PT050D	2733	2883	1386	1462	2714	2902	1376	1472	8464
30XW1052PT050A	2740	2890	1393	1469	2721	2909	1383	1479	8492
30XW1262PT050D	2324	2940	1830	2315	2262	3003	1779	2365	9409
30XW1262PT050A	2358	2974	1863	2349	2296	3037	1813	2399	9544
30XW1402PT050D	2316	2968	1924	2468	2250	3035	1868	2524	9677
30XW1402PT050A	2378	3030	1986	2530	2312	3097	1930	2586	9925
30XW1602PT050D	3314	3467	1472	1541	3295	3486	1463	1550	9794
30XW1602PT050A	3377	3530	1536	1605	3358	3549	1527	1614	10048

Basement drawing

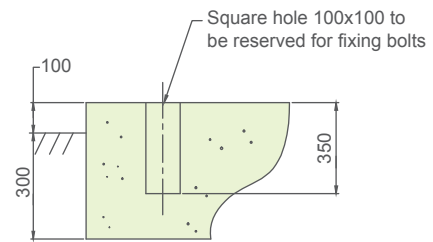
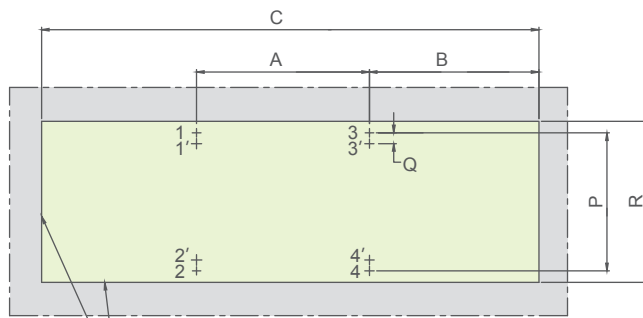

Sectional diagram for fixing bolts

Chiller outline dimension, more space needed when building chiller base

Note:

1. 4 bolts used to fix chiller, bolt size M20x300
2. User can select 1, 2, 3, 4 or 1', 2', 3', 4' as a group to fix bolts

Model	A(mm)	B(mm)	C(mm)	P(mm)	Q(mm)	R(mm)
30XW0502PT050A /D	1600	832	3365	1035	75	1085
30XW0702PT050A /D	1200	1177	3454	958	75	1119
30XW0902PT050A /D	1500	947	3274	1178	100	1258
30XW1052PT050A /D	1745	1521	4888	1178	100	1338
30XW1262PT050A /D	1745	1522	4891	1178	100	1338
30XW1402PT050A /D	1745	1522	4891	1178	100	1338
30XW1602PT050A /D	1745	1524	4891	1178	100	1338

Lifting drawing

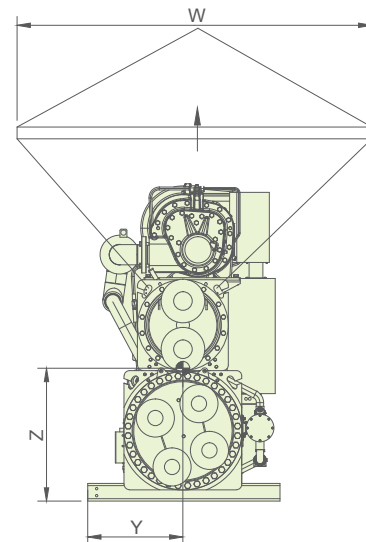
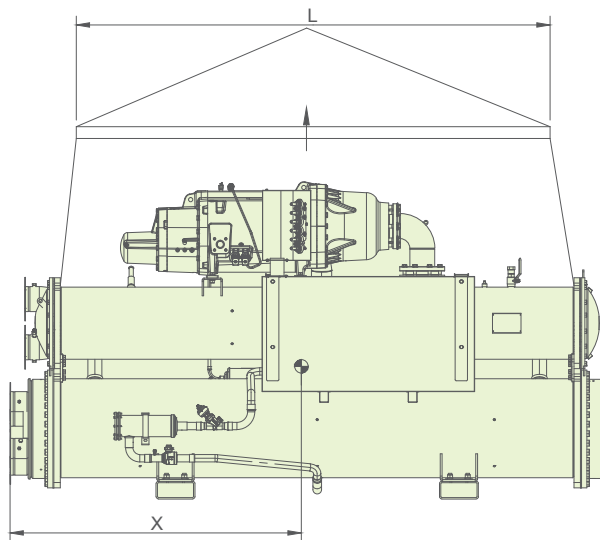

Model	X(mm)	Y(mm)	Z(mm)	L(mm) Minimum	W(mm) Minimum
30XW0502PT050A /D	1622	569	888	2000	1200
30XW0702PT050A /D	1603	559	938	2000	1200
30XW0902PT050A /D	1515	571	947	2000	1200
30XW1052PT050A /D	2434	606	1085	4800	1400
30XW1262PT050A /D	2394	737	1132	4800	1400
30XW1402PT050A /D	2418	740	1172	4800	1400
30XW1602PT050A /D	2399	600	1229	4800	1400

Pressure drop curve of 30XW total heat recovery

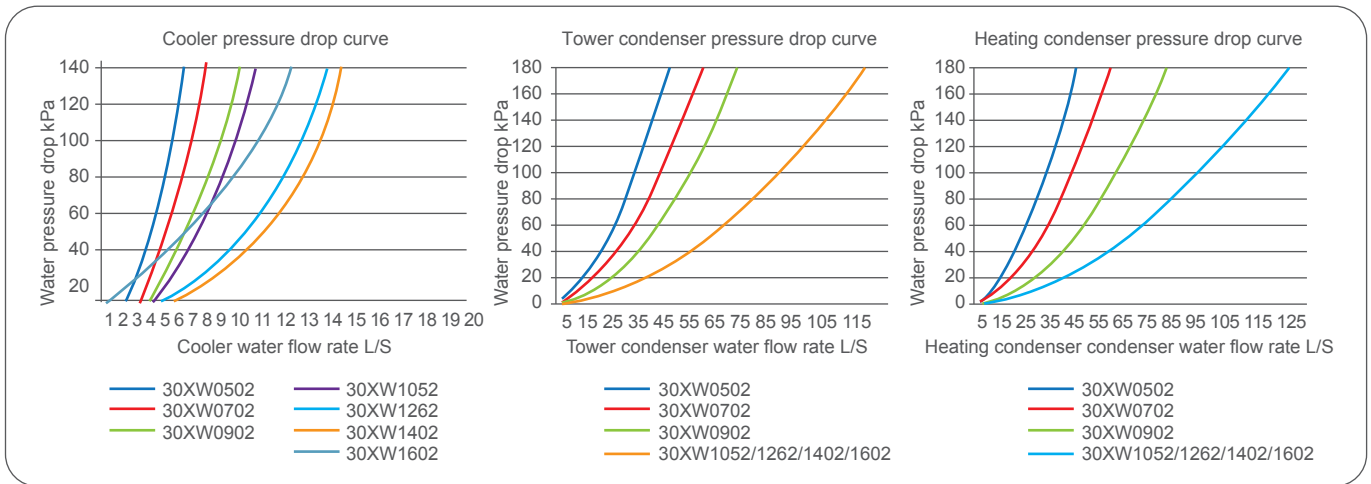

Water flow rate range (L/s)

30XW total heat recovery	Tower/heating condenser		Evaporator	
	min*	max**	min*	max**
0502	3.7	33.3	5.9	35.3
0702	4.9	48.7	8.7	49.3
0902	7.1	72.6	8.7	49.3
1052	10.1	101.2	11.9	66.0
1262	10.1	101.2	14.6	87.3
1402	10.2	101.2	15.3	92.6
1602	10.2	101.2	16.9	103.3

* Based on water flow rate was 0.5 (m/s)
 ** Based on water flow rate was 3.05 (m/s)

Minimum chilled water flow

If the system flow is less than the minimum unit flow rate, the evaporator flow can be recirculated, as shown in the diagram. For minimum chilled water flow rate

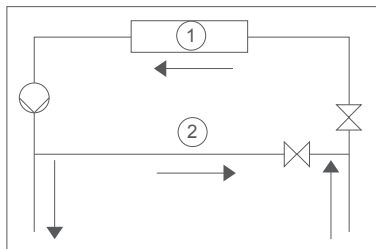

- 1. Evaporator
- 2. Recirculation

Maximum chilled water flow

The maximum chilled water flow is limited by the permitted pressure drop in the evaporator. Bypass the evaporator as shown in the diagram to obtain a lower evaporator flow rate. For maximum chilled water flow rate

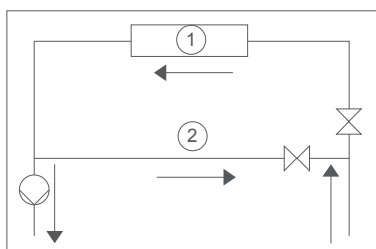

- 1. Evaporator
- 2. Bypass

System minimum water volume

For better control of leaving water temperature, the water loop minimum capacity is given by the formula:

$$\text{Capacity} = \text{CAP (kW)} \times \text{N Liters}$$

Application	N
Normal air conditioning	3.5
	3.5
Process cooling	6.5
	6.5

Where Cap is the nominal system cooling capacity (kW) at the nominal operating conditions of the installation.

This volume is necessary for stable operation and accurate temperature control.

It is often necessary to add a buffer water tank to the circuit in order to achieve the required volume. The tank must be internally baffled in order to ensure proper mixing of the liquid (water or brine). Refer to the examples below.

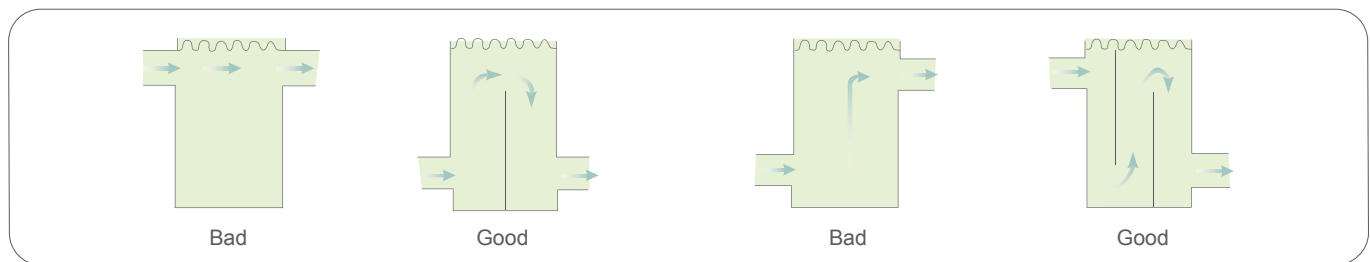

Wiring diagram

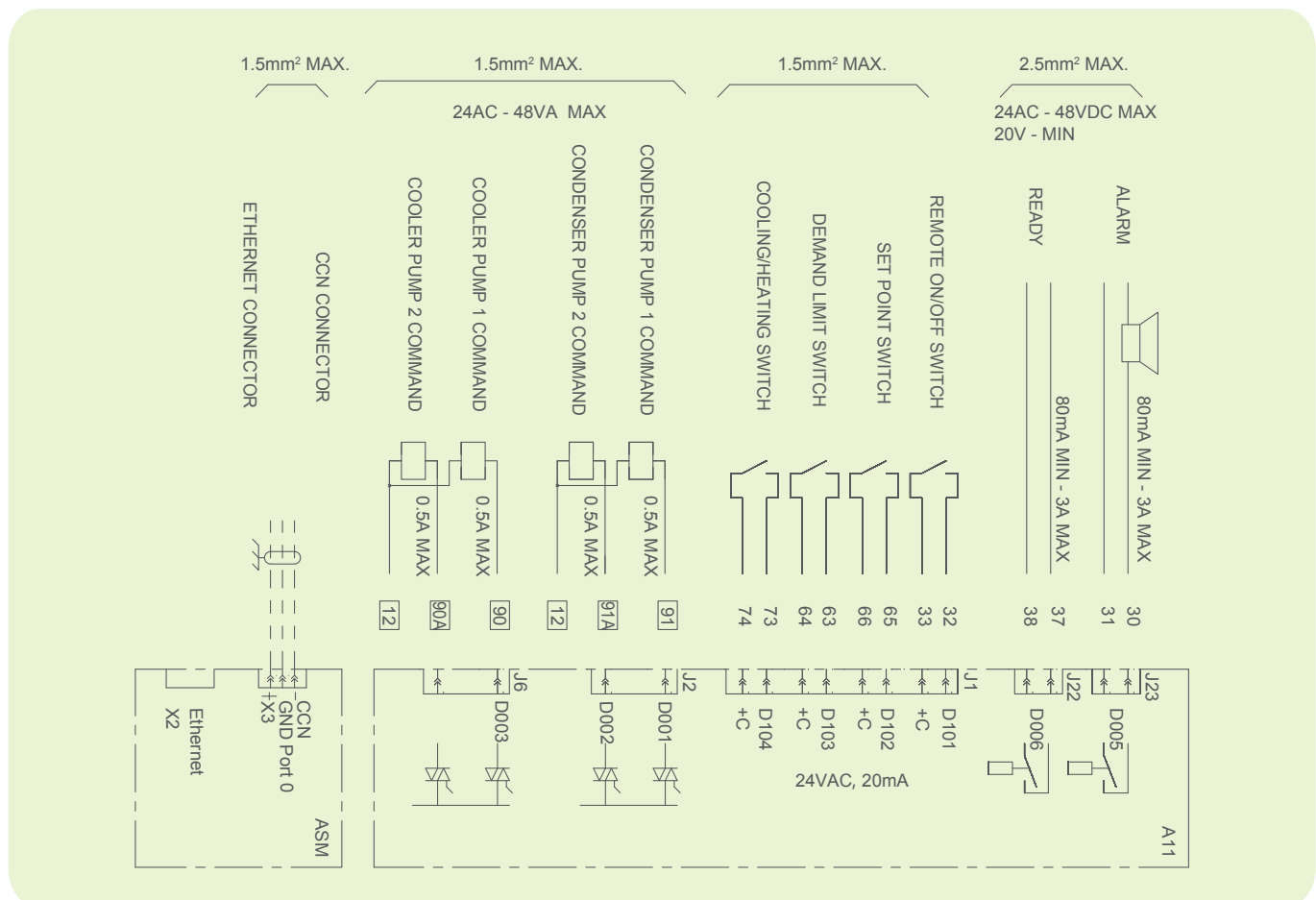



Carrier improves the world around us; Carrier improves people's lives; our products and services improve building performance; our culture of improvement will not allow us to rest when it comes to the environment.



www.carrier.com

The Manufacturer reserves the right to change any product specifications without prior notices
© All Rights Reserved Carrier

Version:	CAT-30XW-HR_E_202008-03
Supersede:	CAT-30XW-HR_E_1612_02
Effective Date:	Aug, 2020