



39GNS Series Air Handling Unit



www.carrier.co.th

World's No. 1 Air Conditioning Expert

Introduction

The purpose of this catalogue is to help consulting engineers in the preliminary selection of CARRIER AIR HANDLING UNITS. However, if required, your local CARRIER office will assist to provide a computerised selection to confirm or complete your preliminary selection.

This catalogue consists of:

- A description of the various component parts available to be combined in the order best suited to your requirements.
- Technical data sheets, dimensions, weights, specifications, charts, etc.

QUALITY

The quality and reliability of any system depends on the quality of the components parts. Equipment schedules and specifications are based on **Carrier 39CNE**.

Therefore, in line with other CARRIER products, our 39GNS Series Air Handlers are manufactured in conformity with CARRIER's Quality concept which brought in items subjected to rigorous inspection.

FLEXIBLE MODULAR CONSTRUCTION

This adaptable unit design which is based upon a wide range of standard panel sizes, frequently enables CARRIER to offer several configurations of unit height and width, so that the aesthetic or practical dictates of confined plant room space or rooftop silhouettes can be easily met.

Major items of unit such as fans, coils, filters, etc. can be arranged in the sequence dictated by the job requirements, and separated by access sections where necessary, giving complete flexibility of design.

RIGIDITY

Extruded aluminium internal posts within the extruded aluminium frame increase the structural rigidity and provide a fixing point for an air-tight sealing strip.

The panels shall be constructed such that they shall be of two layers of steel sheet with injected insitu CFC-Free Polyurethane insulation with thermal conductivity factor of 0.019 W.mK and density of 40kg.m³ in between to ensure effective thermal and acoustic insulation.

WIDE RANGE OF SIZES

There are 43 standard units sizes available, each, in most cases, has a choice of 2 fan type, covering ranging from 800 to 43,000 Nominal CFM.

WIDE RANGE OF COILS OFFERING

Chiller water coil - 1, 2, 3, 4, 5, 6, 7, 8, 10 rows with 8, 10, 12, 14 fin per inch.

Hot Water Coil - 1, 2, 3, 4, 5, 6, 7, 8, 10 rows with 8, 10, 12, 14 fin per inch.

Optimized coil circuiting.

3/8" and 1/2" tube diameter standard.

Aluminum fins (standard) or option as Pre coated (Blue Fin), Copper fin, Hydrophobic coated.

Remark : Coils performance are designed in accordance to ARI Standard 410.

FLEXIBILITY IN PANEL CONSTRUCTION

Units are offered with double wall construction sheet metal with 26 Gauge Colorbond® XMA (ABR) as Outer casing and 26 Gauge Galvanized Steel as Inner Casing for 25 mm. and 50 mm.

VIBRATION ISOLATION

Centrifugal fan motor packages are mounted on common bases with 1 deflection spring or 0.5 deflection rubber follow factory standard vibration isolators and flexible discharge connections ensuring that all moving parts are independently isolated from the casing structure.

AESTHETICS

The standard construction features external panels surface attractively finished with Colorbond® XMA (ABR) and the units are delivered with plastic covering which keep the panels in good condition.

ACCESSIBILITY AND MAINTENANCE

The easily removable panels and quick release access doors offer complete accessibility to fans, coils, filters and dampers. Additional access sections can be provided between coils and filters if required.

All basic component parts are standard and interchangeable. Filters are commercially available standard items conforming to international standards and sizes.

INDIVIDUALISED PRODUCT LINE

All 43 model sizes are available as 'Customised' adapted exactly to meet specific job requirements. For example: Non-standard coil material stainless drainpan / stainless casing / low leak damper / Hepa filter and etc.

MODEL NUMBER NOMENCLATURE

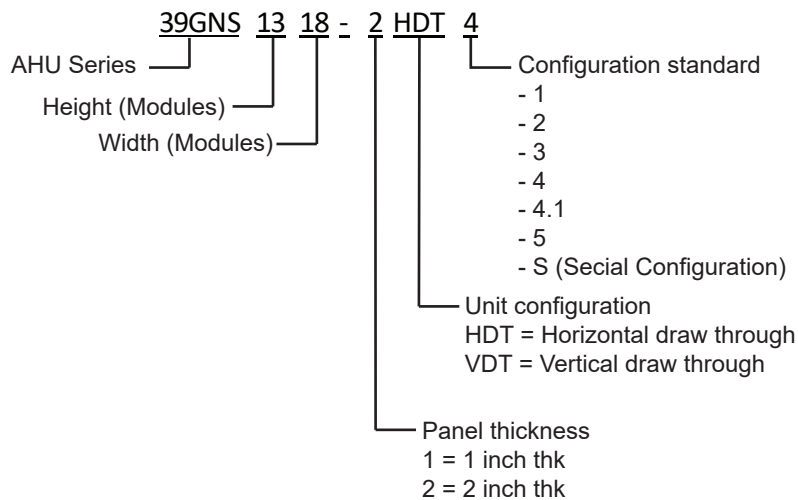

39GNS Identification & dimension

General

The 39GNS line of Carrier Air Handling Unit is based on a MODULAR System

The number of modules in height and in width determine the cross-section available for air flow and encodes the unit size.

The unit length is determined by the number and size of the component parts required.

The side for service (connections and access) is defined as right hand or left hand in the direction of air flow.

Each module has a constant value of 100mm. To determine external dimensions, the following formula applies:

External Dimensions	=	$(N \times 100 + M)$ mm
Where N	=	number of module
M	=	60 mm for 25 mm casing
M	=	110 mm for 50 mm casing

Example 1: 39GNS0711 for 50mm casing

External Height Dimension	=	$07 \times 100 + 110 = 810$ mm
External Width Dimension	=	$11 \times 100 + 110 = 1,210$ mm

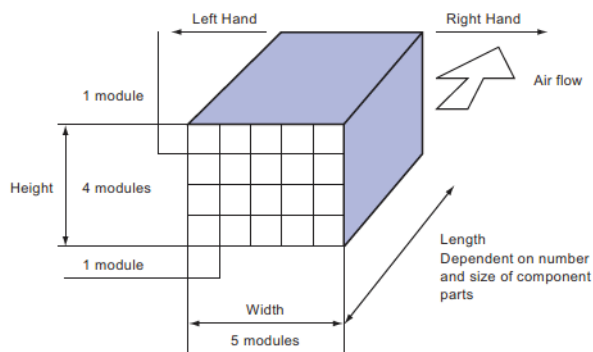

Remark : Must add base frame (100 mm.) to external height dimension to get the overall height of unit
Overall dimension excluded damper, pipe connection, discharge flange.

Quick Selection 39GNS

39GNS SIZE	Coil Tube Diameter	COIL FACE		AIR VOLUME												Dimensions (mm)		
		ARER		2 m/s		2.5 m/s		3 m/s		3.5 m/s		3 m/s		25 mm Thickness		50 mm Thickness		
		(sq.m)	(sq.ft)	CMH	CFM	CMH	CFM	CMH	CFM	CMH	CFM	CMH	CFM	H	W	H	W	
0608	1/2"	0.257	2.77	1.549	912	1.945	1,145	0.54	1,378	2.341	1,378	0.65	2,737	1,611	760	860	810	910
0609	3/8"	0.265	2.85	1.909	1,124	2.377	1,399	0.66	1,696	2.882	1,696	0.8	3,350	1,972	760	860	810	910
	1/2"	0.303	3.26	2,716	1,272	2,716	1,600	0.76	3,278	1,929	1,929	0.91	3,818	2,247	760	960	810	1,010
0610	3/8"	0.311	3.35	2,233	1,314	2,809	1,654	0.78	3,350	1,972	1,972	0.93	3,926	2,311	760	960	810	1,010
	1/2"	0.347	3.73	2,485	1,463	3,118	1,835	0.87	3,746	2,205	2,205	1.04	4,358	2,565	760	1,060	810	1,110
0711	3/8"	0.357	3.84	2,557	1,505	3,206	1,887	0.89	3,854	2,268	2,268	1.07	4,502	2,650	760	1,060	810	1,110
	1/2"	0.447	4.81	3,206	1,887	4,018	2,365	1.12	4,827	2,841	2,841	1.34	5,619	3,307	860	1,160	910	1,210
0712	3/8"	0.447	4.81	3,206	1,887	4,018	2,365	1.12	4,827	2,841	2,841	1.34	5,619	3,307	860	1,160	910	1,210
	1/2"	0.498	5.36	3,602	2,120	4,466	2,629	1.24	5,367	3,159	3,159	1.49	6,267	3,689	860	1,260	910	1,310
0811	3/8"	0.498	5.36	3,602	2,120	4,466	2,629	1.24	5,367	3,159	3,159	1.49	6,267	3,689	860	1,260	910	1,310
	1/2"	0.558	6.01	4,034	2,374	4,827	2,955	1.4	6,051	3,562	3,562	1.68	7,060	4,155	960	1,360	1,110	1,410
0813	3/8"	0.556	5.77	3,854	2,268	4,827	2,841	1.34	5,799	3,413	3,413	1.61	6,772	3,986	960	1,360	1,110	1,410
	1/2"	0.686	7.38	4,935	2,904	6,167	3,630	1.71	7,420	4,367	4,367	2.06	8,645	5,088	960	1,360	1,110	1,410
0912	3/8"	0.658	7.08	4,754	2,798	5,943	3,498	1.65	7,132	4,198	4,198	1.98	8,284	4,876	960	1,360	1,110	1,410
	1/2"	0.685	7.37	4,935	2,904	6,159	3,625	1.71	7,384	4,346	4,346	2.05	8,645	5,088	1,060	1,260	1,110	1,310
0913	3/8"	0.697	7.50	5,007	2,947	6,267	3,689	1.74	7,528	4,431	4,431	2.09	8,789	5,173	1,060	1,260	1,110	1,310
	1/2"	0.754	8.12	5,439	3,201	6,796	4,000	1.89	8,140	4,791	4,791	2.26	9,509	5,597	1,060	1,360	1,110	1,410
0914	3/8"	0.768	8.27	5,547	3,265	6,916	4,070	1.92	8,284	4,876	4,876	2.3	9,689	5,703	1,060	1,360	1,110	1,410
	1/2"	0.825	8.88	5,943	3,498	7,420	4,367	2.06	8,897	5,236	5,236	2.47	10,373	6,106	1,060	1,460	1,110	1,510
1015	3/8"	0.839	9.03	6,051	3,562	7,564	4,452	2.1	9,077	5,342	5,342	2.52	10,590	6,233	1,160	1,560	1,210	1,610
	1/2"	1.057	11.38	7,600	4,473	9,509	5,597	2.64	11,418	6,720	6,720	3.17	13,327	7,844	1,160	1,560	1,210	1,610
1016	3/8"	1.041	11.20	7,492	4,410	9,365	5,512	2.6	11,238	6,614	6,614	3.12	13,111	7,717	1,160	1,560	1,210	1,610
	1/2"	1.139	12.26	8,212	4,834	10,265	6,042	2.85	12,318	7,250	7,250	3.42	14,372	8,459	1,160	1,660	1,210	1,710
1117	3/8"	1.121	12.07	8,068	4,749	10,085	5,936	2.8	12,102	7,123	7,123	3.36	14,155	8,332	1,160	1,660	1,210	1,710
	1/2"	1.372	14.77	9,869	5,809	12,354	7,272	3.43	14,804	8,713	8,713	4.11	17,289	10,176	1,260	1,760	1,310	1,810
1317	3/8"	1.317	14.18	9,473	5,676	11,850	6,975	3.29	14,227	8,374	8,374	3.95	16,605	9,773	1,460	1,760	1,510	1,810
	1/2"	1.646	17.72	11,850	6,975	14,804	8,713	4.11	17,793	10,473	10,473	4.94	20,747	12,211	1,460	1,760	1,510	1,810
1318	3/8"	1.609	17.32	11,598	6,826	14,480	8,522	4.02	17,397	10,240	10,240	4.83	20,279	11,936	1,460	1,860	1,510	1,910
	1/2"	1.760	18.94	12,679	7,462	15,848	9,328	4.4	19,018	11,194	11,194	5.28	22,188	13,059	1,460	1,860	1,510	1,910
1320	3/8"	1.721	18.52	12,390	7,293	15,488	9,116	4.3	18,586	10,939	10,939	5.16	21,693	12,762	1,460	2,060	1,510	2,110
	1/2"	1.989	21.41	14,335	8,438	17,901	10,536	4.97	21,503	12,656	12,656	5.97	25,069	14,755	1,460	2,060	1,510	2,110
1322	3/8"	1.944	20.93	14,011	8,247	17,505	10,303	4.86	20,999	12,360	12,360	5.83	24,529	14,437	1,460	2,060	1,510	2,110
	1/2"	2.219	23.88	15,956	9,392	19,954	11,745	5.54	23,953	14,098	14,098	6.65	27,951	16,451	1,460	2,260	1,510	2,310
1418	3/8"	2.168	23.34	15,632	9,201	19,522	11,490	5.42	23,412	13,780	13,780	6.5	27,338	16,091	1,460	2,260	1,510	2,310
	1/2"	1.857	19.99	13,399	7,886	16,749	9,858	4.65	20,098	11,830	11,830	5.58	23,448	13,801	1,560	1,860	1,610	1,910
1420	1/2"	2.100	22.60	15,128	8,904	18,910	11,130	5.25	22,692	13,356	13,356	6.3	26,474	15,582	1,560	2,060	1,610	2,110
	1/2"	2.219	23.88	15,992	9,413	19,990	11,766	5.55	23,989	14,119	14,119	6.66	27,987	16,472	1,560	2,060	1,610	2,110
1422	1/2"	2.341	25.20	16,857	9,922	21,071	12,402	5.85	25,285	14,882	14,882	7.02	29,499	17,363	1,560	2,260	1,610	2,310
	1/2"	2.052	22.09	14,768	8,692	18,478	10,876	5.13	22,152	13,038	13,038	6.15	25,861	15,222	1,660	1,860	1,710	1,910
1521	1/2"	2.453	26.40	17,649	10,388	22,080	12,996	6.13	26,474	15,582	15,582	7.35	30,904	18,190	1,660	2,160	1,710	2,210

Quick Selection 39GNS

39GNS SIZE	Coil Tube Diameter (in)	COIL FACE ARER		AIR VOLUME												Dimensions (mm)			
		(sq.m)	(sq.ft)	2 m/s		2.5 m/s		3 m/s		3.5 m/s		3.5 m/s (L/s*1000)	25 mm Thickness		50 mm Thickness				
				CMH	CFM	CMH	CFM	CMH	CFM	CMH	CFM		H	W	H	W			
1522	1/2"	2.587	27.85	18.658	10.982	5.18	23,276	13,700	6.48	27,987	16,472	7.77	32,669	19,228	9.07	1,660	2,260	1,710	2,310
1524	1/2"	2.855	30.73	20.531	12.084	5.7	25,681	15,116	7.13	30,796	18,126	8.55	35,947	21,158	9.98	1,660	2,460	1,710	2,510
1525	1/2"	2.988	32.16	21.539	12.678	5.98	26,844	15,800	7.48	32,309	19,016	8.97	37,712	22,196	10.47	1,660	2,560	1,710	2,610
1621	1/2"	2.569	27.65	18.514	10.897	5.14	23,160	13,632	6.43	27,770	16,345	7.71	32,417	19,080	9	1,760	2,160	1,810	2,210
1622	1/2"	2.711	29.18	19.522	11.490	5.42	24,421	14,374	6.78	29,283	17,236	8.13	34,182	20,119	9.49	1,760	2,260	1,810	2,310
1624	1/2"	2.991	32.20	21.539	12.678	5.98	26,942	15,858	7.48	32,309	19,016	8.97	37,712	22,196	10.47	1,760	2,460	1,810	2,510
1625	1/2"	3.130	33.69	22.548	13.271	6.26	28,203	16,600	7.83	33,822	19,907	9.39	39,477	23,235	10.96	1,760	2,560	1,810	2,610
1822	1/2"	3.081	33.16	22,188	13,059	6.16	28,798	16,950	7.7	33,281	19,589	9.24	38,828	22,854	10.78	1,960	2,260	2,010	2,310
1824	1/2"	3.399	36.59	24,493	14,416	6.8	31,771	18,700	8.5	36,739	21,624	10.2	42,862	25,228	11.9	1,960	2,460	2,010	2,510
1825	1/2"	3.556	38.28	25,645	15,094	7.12	33,215	19,550	8.9	38,468	22,642	10.68	44,879	26,415	12.46	1,960	2,560	2,010	2,610
2025	1/2"	3.984	42.88	28,707	16,896	7.97	35,875	21,115	9.96	43,042	25,334	11.95	50,210	29,553	13.94	2,160	2,560	2,210	2,610
2125	1/2"	4.126	44.41	29,716	17,490	8.25	38,397	22,600	10.31	44,555	26,224	12.37	52,011	30,613	14.44	2,260	2,560	2,310	2,610
2226	1/2"	4.605	49.57	33,173	19,525	9.21	41,494	24,422	11.52	49,778	29,298	13.82	58,062	34,174	16.12	2,360	2,660	2,410	2,710
2230	1/2"	5.395	58.07	38,864	22,875	10.79	48,553	28,578	13.48	58,278	34,302	16.18	68,003	40,026	18.88	2,360	3,060	2,410	3,110
2234	1/2"	6.180	66.52	44,519	26,203	12.36	55,649	32,754	15.45	66,779	39,305	18.54	77,909	45,856	21.63	2,360	3,460	2,410	3,510
2330	1/2"	5.569	59.94	40,125	23,617	11.14	50,970	30,000	13.92	60,151	35,404	16.7	70,201	41,319	19.49	2,460	3,060	2,510	3,110
2334	1/2"	6.380	68.67	45,960	27,051	12.76	57,766	34,000	15.95	68,940	40,577	19.14	80,430	47,340	22.33	2,460	3,460	2,510	3,510
2434	1/2"	6.778	72.96	48,841	28,747	13.56	61,052	35,934	16.95	73,262	43,121	20.34	85,473	50,308	23.73	2,560	3,460	2,610	3,510
2634	1/2"	7.376	79.40	53,128	31,270	14.75	66,419	39,093	18.44	79,710	46,916	22.13	93,001	54,738	25.82	2,760	3,460	2,810	3,510
2636	1/2"	7.848	84.47	56,513	33,263	15.69	70,669	41,594	19.62	84,788	49,905	23.54	98,944	58,236	27.47	2,760	3,660	2,810	3,710

- For cooling application of face velocity more than 2.54 m/s , drift eliminators is recommended to avoid moisture carry over under normal operating condition.

- Horizontal Unit

- Height of unit (H) included unit case 100 mm.

Unit Configuration Horizontal

39GNS Horizontal Configuration 1

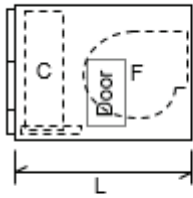

Fig.1A

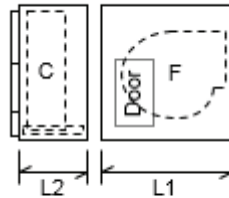

Fig.1B

- Unit configuration 1 consist of Fan + Coil + Filter Track
- Coil section length 6 modules
- Filter track for pre-filter 2"thk. Only (front loading).
- Height of unit (H) included unit base 100 mm.

39GNS Horizontal Configuration 2

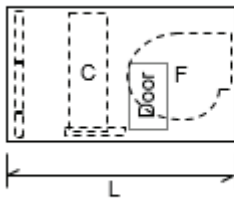

Fig.2A

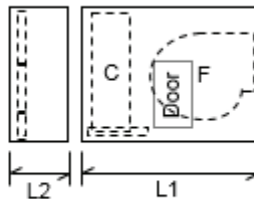

Fig.2B

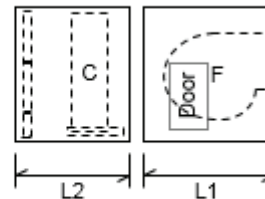

Fig.2C

- Unit configuration 2 consist of Fan + Coil + Filter section with track
- Coil section length 6 modules
- Filter section with track (front loading) length 6 modules.
- Height of unit (H) included unit base 100 mm.

Unit Configuration Horizontal

39GNS Horizontal Configuration 3

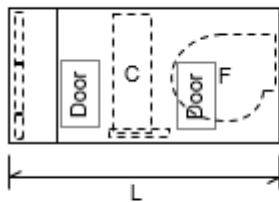

Fig.3A

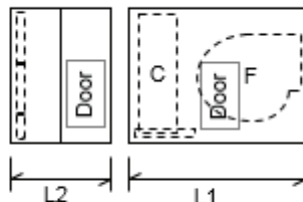

Fig.3B

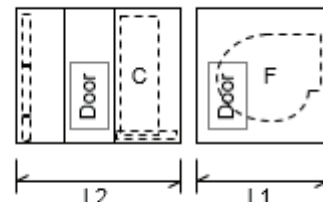

Fig.3C

- Unit configuration 3 consist of Fan + Coil + Access section + Filter section with track
- Coil section length 6 modules
- Access section length 5 modules
- Filter section length 6 modules
- Height of unit (H) included unit base 100 mm.

39GNS Horizontal Configuration 4

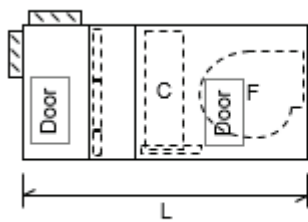

Fig.4A

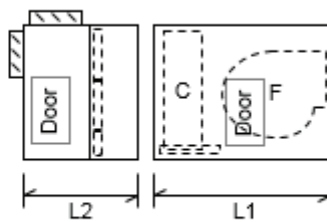

Fig.4B

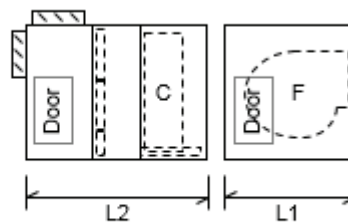

Fig.4C

- Unit configuration 4 consist of Fan + Coil + Filter section with track + Mixing Box with damper.
- Coil section length 6 modules
- Mixing section length 5-9 modules.
- Filter section length 6 modules
- Height of unit (H) included unit base 100 mm.

Unit Configuration Horizontal

39GNS Horizontal Configuration 4.1

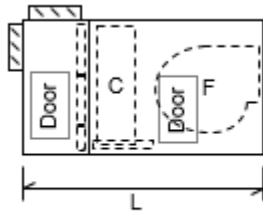

Fig.4.1A

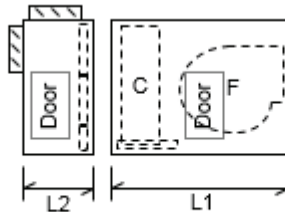

Fig.4.1B

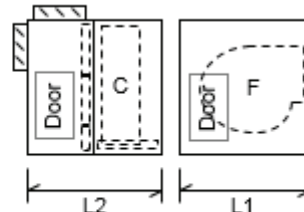

Fig.4.1C

- Unit configuration 4.1 consist of Fan + Coil + Filter track + Mixing Box with damper
- Coil section length 6 modules.
- Mixing section length 5-9 modules.
- Filter track for pre-filter 2"thk. only (front loading).
- Height of unit (H) included unit base 100 mm.

39GNS Horizontal Configuration 5

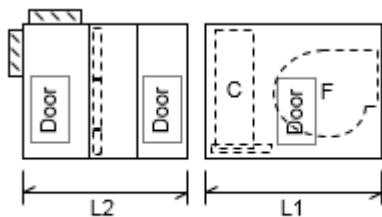

Fig.5A

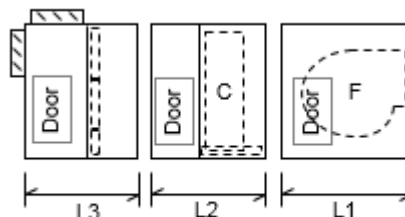

Fig.5B

- Unit configuration 5 consist of Fan + Coil + Access section + Filter section with track + Mixing Box
- Coil section length 6 modules
- Access section length 5 modules
- Mixing section length 5-9 modules.
- Filter section length 6 modules
- Height of unit (H) included unit base 100 mm.

39GNS - MODULES LENGTH (HDT)

39GS	Fan	HDT - 1 Fan+ Coil	HDT - 2 Fan+Coil +Filter	HDT - 3 Fan+Coil+ Acc. +Filter	HDT - 4.1 Fan+Coil +MXB	HDT - 4 Fan+Coil+ Filter+ MXB	HDT - 5 Fan+Coil+Acc +Fil.+ MXB
0608	180	(6+6)	(6+6+6)	(6+6+5+6)	(6+6+5)	(6+6+6+5)	(6+6) - (5+6+5)
0609	180	(6+6)	(6+6+6)	(6+6+5+6)	(6+6+5)	(6+6+6+5)	(6+6) - (5+6+5)
0610	200	(7+6)	(7+6+6)	(7+6+5+6)	(7+6+5)	(7+6+6+5)	(7+6) - (5+6+5)
	180	(6+6)	(6+6+6)	(6+6+5+6)	(6+6+5)	(6+6+6+5)	(6+6) - (5+6+5)
	200	(7+6)	(7+6+6)	(7+6+5+6)	(7+6+5)	(7+6+6+5)	(7+6) - (5+6+5)
0711	200, 225	(7+6)	(7+6+6)	(7+6+5+6)	(7+6+5)	(7+6+6+5)	(7+6) - (5+6+5)
0712	225, 250	(7+6)	(7+6+6)	(7+6+5+6)	(7+6+5)	(7+6+6+5)	(7+6) - (5+6+5)
0811	225, 250	(7+6)	(7+6+6)	(7+6+5+6)	(7+6+5)	(7+6+6+5)	(7+6) - (5+6+5)
0813	280, 315	(8+6)	(8+6+6)	(8+6+5+6)	(8+6+5)	(8+6+6+5)	(8+6) - (5+6+5)
0912	250	(7+6)	(7+6+6)	(7+6) - (5+6)	(7+6+5)	(7+6) - (6+5)	(7+6) - (5+6+5)
0913	280, 315	(8+6)	(8+6+6)	(8+6) - (5+6)	(8+6+5)	(8+6) - (6+5)	(8+6) - (5+6+5)
0914	315	(8+6)	(8+6+6)	(8+6) - (5+6)	(8+6+5)	(8+6) - (6+5)	(8+6) - (5+6+5)
	355	(9+6)	(9+6+6)	(9+6) - (5+6)	(9+6+5)	(9+6) - (6+5)	(9+6) - (5+6+5)
	355	(9+6)	(9+6+6)	(9+6) - (5+6)	(9+6+5)	(9+6) - (6+5)	(9+6) - (5+6+5)
1015	400	(10+6)	(10+6+6)	(10+6) - (5+6)	(10+6+5)	(10+6) - (6+5)	(10+6) - (5+6+5)
1016	355	(9+6)	(9+6+6)	(9+6) - (5+6)	(9+6+5)	(9+6) - (6+5)	(9+6) - (5+6+5)
	400	(10+6)	(10+6+6)	(10+6) - (5+6)	(10+6+5)	(10+6) - (6+5)	(10+6) - (5+6+5)
	450	(11+6)	(11+6+6)	(11+6) - (5+6)	(11+6+5)	(11+6) - (6+5)	(11+6) - (5+6+5)
1317	400	(10+6)	(10+6+6)	(10+6) - (5+6)	(10+6+5)	(10+6) - (6+5)	(10+6) - (5+6+5)
	450	(11+6)	(11+6+6)	(11+6) - (5+6)	(11+6+5)	(11+6) - (6+5)	(11+6) - (5+6+5)
1318	400	(10+6)	(10+6+6)	(10+6) - (5+6)	(10+6+5)	(10+6) - (6+5)	(10+6) - (5+6+5)
	450	(11+6)	(11+6+6)	(11+6) - (5+6)	(11+6+5)	(11+6) - (6+5)	(11+6) - (5+6+5)
1418	450, 500	(11+6)	(11+6) - (6)	(11+6) - (5+6)	(11+6+6)	(11+6) - (6+6)	(11+6) - (5+6+6)
1320	450, 500	(11+6)	(11+6) - (6)	(11+6) - (5+6)	(11+6+6)	(11+6) - (6+6)	(11+6) - (5+6+6)
1518	450, 500	(11+6)	(11+6) - (6)	(11+6) - (5+6)	(11+6+6)	(11+6) - (6+6)	(11+6) - (5+6+6)
	500	(11+6)	(11+6) - (6)	(11+6) - (5+6)	(11+6+6)	(11+6) - (6+6)	(11+6) - (5+6+6)
	560	(13+6)	(13+6) - (6)	(13+6) - (5+6)	(13+6+6)	(13+6) - (6+6)	(13+6) - (5+6+6)
1322	500	(11+6)	(11+6) - (6)	(11+6) - (5+6)	(11+6+6)	(11+6) - (6+6)	(11+6) - (5+6+6)
	560	(13+6)	(13+6) - (6)	(13+6) - (5+6)	(13+6+6)	(13+6) - (6+6)	(13+6) - (5+6+6)
1421	500	(11+6)	(11+6) - (6)	(11+6) - (5+6)	(11+6+6)	(11+6) - (6+6)	(11+6) - (5+6+6)
	560	(13+6)	(13+6) - (6)	(13+6) - (5+6)	(13+6+6)	(13+6) - (6+6)	(13+6) - (5+6+6)
1422	500	(11+6)	(11+6) - (6)	(11+6) - (5+6)	(11+6+6)	(11+6) - (6+6)	(11+6) - (5+6+6)
	560	(13+6)	(13+6) - (6)	(13+6) - (5+6)	(13+6+6)	(13+6) - (6+6)	(13+6) - (5+6+6)
1521	500	(11+6)	(11+6) - (6)	(11+6) - (5+6)	(11+6+6)	(11+6) - (6+6)	(11+6) - (5+6+6)
	560	(13+6)	(13+6) - (6)	(13+6) - (5+6)	(13+6+6)	(13+6) - (6+6)	(13+6) - (5+6+6)

Unit Configuration Vertical

39GNS Vertical-Configuration 1

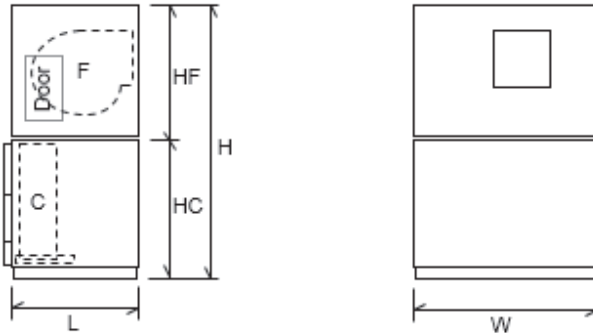

- Unit configuration 1 consist of Fan+Coil+Filter Track
- Filter rack for pre-filter 2" thk.Only (frontloading).
- Height of unit (H) included unit base 100 mm.
- 39GNS larger than size 1625, are not available for VDT units.

39GNS Vertical-Configuration 2

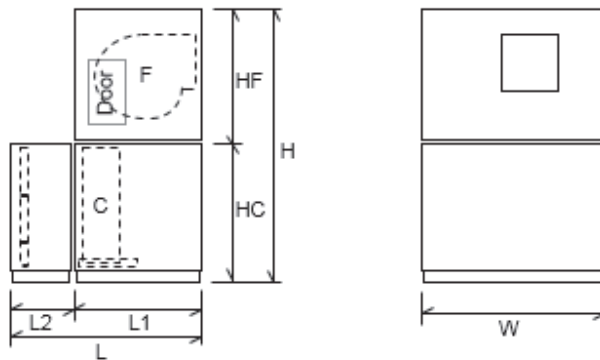

- Unit configuration 2 consist of Fan+Coil+Filter section with track.
- Coil section length 6 modules.
- Filter section with rack (front loading) length 6 modules.
- Height of unit (H) included unit base 100 mm.
- 39GNS larger than size 1625, are not available for VDT units.

Unit Configuration Vertical

39GNS Vertical-Configuration 3

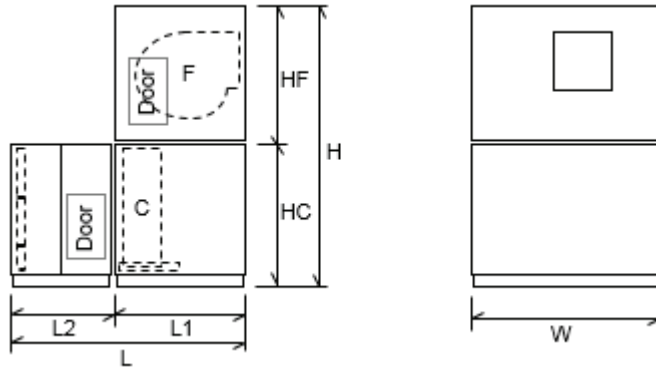

- Unit configuration 3 consist of Fan + Coil + Access Section+ Filter Section with track
- Access section length 5 modules
- Filter section length 6 modules
- Height of unit (H) included unit base 100 mm .
- 39GNS larger than size 1625, are not available for VDT units .

39GNS Vertical-Configuration 4

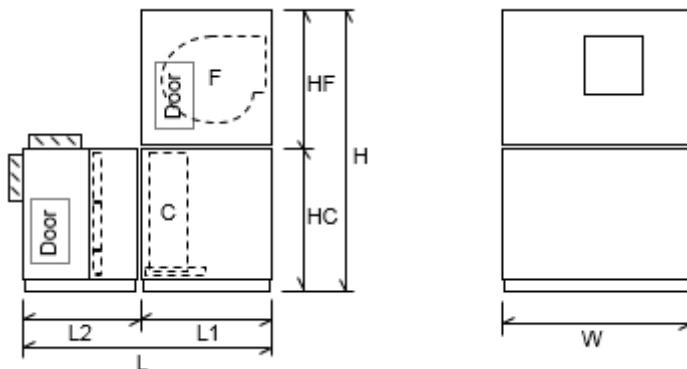

- Unit configuration 4 consist of Fan + Coil + Filter section with track + Mixing Box
- Filter section length 6 modules
- Height of unit (H) included unit base 100 mm .
- 39GNS larger than size 1625, are not available for VDT units .

Unit Configuration Vertical

39GNS Vertical-Configuration 4.1

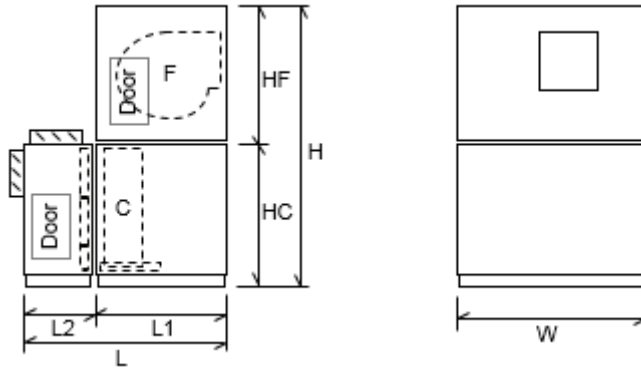

- Unit configuration 4.1 consist of Fan + Coil + Filter track + Mixing Box
- Filter track for pre-filter 2" thk. Only (front loading).
- Height of unit (H) included unit base 100 mm.
- 39GNS larger than size 1625, are not available for VDT units.

39GNS Vertical-Configuration 5

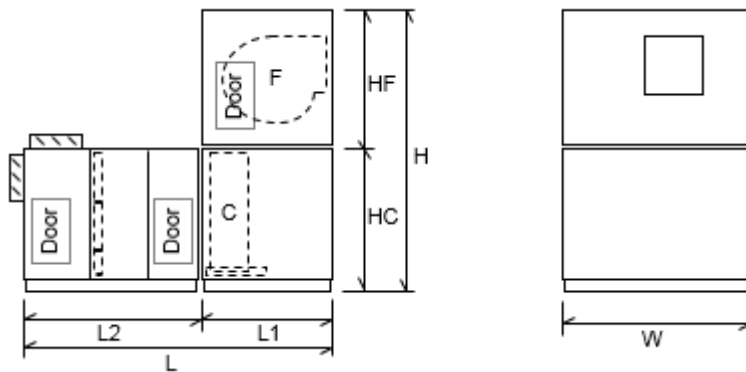

- Unit configuration 5 consist of Fan + Coil + Access section+ Filter section with track + Mixing Box
- Access section length 5 modules
- Filter section length 6 modules
- Height of unit (H) included unit base 100 mm.
- 39GNS larger than size 1625, are not available for VDT units.

*Vertical unit, factory will pre-join fan section and coil section for 39GNS1117 and below.

39GNS - MODULES LENGTH (VDT)

39GNS	Fan		Height (modules)		Unit Length (modules)						
	Fan		Coil		VDT - 1	VDT - 2	VDT - 3	VDT - 4.1	VDT - 4	VDT - 5	
	Fan	Coil	(Fan+Coil)	(Fan+Coil) - (Filter)	(Fan+Coil) - (Filter)	(Fan+Coil) - (Acc.+Filter)	(Fan+Coil) - (MXB)	(Fan+Coil) - (Filter+MXB)	(Fair+Coil) - (Acc+Fil.+MXB)		
0608	180	6	(8)	(8)	(8) - (6)	(8) - (5+6)	(8) - (5)	(8) - (6+5)	(8) - (5+6+5)		
0609	180	6	(8)	(8)	(8) - (6)	(8) - (5+6)	(8) - (5)	(8) - (6+5)	(8) - (5+6+5)		
200	180	6	(8)	(8)	(8) - (6)	(8) - (5+6)	(8) - (5)	(8) - (6+5)	(8) - (5+6+5)		
0610	200	6	(8)	(8)	(8) - (6)	(8) - (5+6)	(8) - (5)	(8) - (6+5)	(8) - (5+6+5)		
0711	200,225	7	(8)	(8)	(8) - (6)	(8) - (5+6)	(8) - (5)	(8) - (6+5)	(8) - (5+6+5)		
0712	225,250	7	(8)	(8)	(8) - (6)	(8) - (5+6)	(8) - (5)	(8) - (6+5)	(8) - (5+6+5)		
0811	225,250	8	(8)	(8)	(8) - (6)	(8) - (5+6)	(8) - (5)	(8) - (6+5)	(8) - (5+6+5)		
0813	280,315	8	(9)	(9)	(9) - (6)	(9) - (5+6)	(9) - (5)	(9) - (6+5)	(9) - (5+6+5)		
0912	250	9	(8)	(8)	(8) - (6)	(8) - (5+6)	(8) - (5)	(8) - (6+5)	(8) - (5+6+5)		
0913	280,315	9	(9)	(9)	(9) - (6)	(9) - (5+6)	(9) - (5)	(9) - (6+5)	(9) - (5+6+5)		
0914	315	9	(9)	(9)	(9) - (6)	(9) - (5+6)	(9) - (5)	(9) - (6+5)	(9) - (5+6+5)		
355	355	9	(9)	(9)	(9) - (6)	(9) - (5+6)	(9) - (5)	(9) - (6+5)	(9) - (5+6+5)		
1015	400	10	(10)	(10)	(10) - (6)	(10) - (5+6)	(10) - (5)	(10) - (6+5)	(10) - (5+6+5)		
1016	355	9	(9)	(9)	(9) - (6)	(9) - (5+6)	(9) - (5)	(9) - (6+5)	(9) - (5+6+5)		
400	400	10	(10)	(10)	(10) - (6)	(10) - (5+6)	(10) - (5)	(10) - (6+5)	(10) - (5+6+5)		
400	400	11	(10)	(10)	(10) - (6)	(10) - (5+6)	(10) - (5)	(10) - (6+5)	(10) - (5+6+5)		
450	450	11	(11)	(11)	(11) - (6)	(11) - (5+6)	(11) - (5)	(11) - (6+5)	(11) - (5+6+5)		
1317	400	10	(10)	(10)	(10) - (6)	(10) - (5+6)	(10) - (5)	(10) - (6+5)	(10) - (5+6+5)		
450	450	11	(11)	(11)	(11) - (6)	(11) - (5+6)	(11) - (5)	(11) - (6+5)	(11) - (5+6+5)		
1318	400	10	(10)	(10)	(10) - (6)	(10) - (5+6)	(10) - (5)	(10) - (6+5)	(10) - (5+6+5)		
450	450	11	(11)	(11)	(11) - (6)	(11) - (5+6)	(11) - (5)	(11) - (6+5)	(11) - (5+6+5)		
1418	450	11	(11)	(11)	(11) - (6)	(11) - (5+6)	(11) - (6)	(11) - (6+6)	(11) - (5+6+6)		
500	500	12	(11)	(11)	(11) - (6)	(11) - (5+6)	(11) - (6)	(11) - (6+6)	(11) - (5+6+6)		
450	450	11	(11)	(11)	(11) - (6)	(11) - (5+6)	(11) - (6)	(11) - (6+6)	(11) - (5+6+6)		
500	500	12	(11)	(11)	(11) - (6)	(11) - (5+6)	(11) - (6)	(11) - (6+6)	(11) - (5+6+6)		
1518	450	11	(11)	(11)	(11) - (6)	(11) - (5+6)	(11) - (6)	(11) - (6+6)	(11) - (5+6+6)		
500	500	12	(11)	(11)	(11) - (6)	(11) - (5+6)	(11) - (6)	(11) - (6+6)	(11) - (5+6+6)		
1420	500	12	(11)	(11)	(11) - (6)	(11) - (5+6)	(11) - (6)	(11) - (6+6)	(11) - (5+6+6)		
560	560	13	(13)	(13)	(13) - (6)	(13) - (5+6)	(13) - (6)	(13) - (6+6)	(13) - (5+6+6)		
1322	500	12	(11)	(11)	(11) - (6)	(11) - (5+6)	(11) - (6)	(11) - (6+6)	(11) - (5+6+6)		
560	560	13	(13)	(13)	(13) - (6)	(13) - (5+6)	(13) - (6)	(13) - (6+6)	(13) - (5+6+6)		
500	500	12	(11)	(11)	(11) - (6)	(11) - (5+6)	(11) - (6)	(11) - (6+6)	(11) - (5+6+6)		
560	560	13	(13)	(13)	(13) - (6)	(13) - (5+6)	(13) - (6)	(13) - (6+6)	(13) - (5+6+6)		
1421	560	13	(13)	(13)	(13) - (6)	(13) - (5+6)	(13) - (6)	(13) - (6+6)	(13) - (5+6+6)		
1422	500	12	(11)	(11)	(11) - (6)	(11) - (5+6)	(11) - (6)	(11) - (6+6)	(11) - (5+6+6)		
560	560	13	(13)	(13)	(13) - (6)	(13) - (5+6)	(13) - (6)	(13) - (6+6)	(13) - (5+6+6)		
500	500	12	(11)	(11)	(11) - (6)	(11) - (5+6)	(11) - (6)	(11) - (6+6)	(11) - (5+6+6)		
560	560	13	(13)	(13)	(13) - (6)	(13) - (5+6)	(13) - (6)	(13) - (6+6)	(13) - (5+6+6)		
1521	560	13	(13)	(13)	(13) - (6)	(13) - (5+6)	(13) - (6)	(13) - (6+6)	(13) - (5+6+6)		
1522	560	13	(13)	(13)	(13) - (6)	(13) - (5+6)	(13) - (6)	(13) - (6+6)	(13) - (5+6+6)		
630	630	15	(14)	(14)	(14) - (6)	(14) - (5+6)	(14) - (6)	(14) - (6+6)	(14) - (5+6+6)		
560	560	13	(13)	(13)	(13) - (6)	(13) - (5+6)	(13) - (6)	(13) - (6+6)	(13) - (5+6+6)		
630	630	15	(14)	(14)	(14) - (6)	(14) - (5+6)	(14) - (6)	(14) - (6+6)	(14) - (5+6+6)		
1524	630	15	(14)	(14)	(14) - (6)	(14) - (5+6)	(14) - (6)	(14) - (6+6)	(14) - (5+6+6)		
1525	560	13	(13)	(13)	(13) - (6)	(13) - (5+6)	(13) - (6)	(13) - (6+6)	(13) - (5+6+6)		
630	630	15	(14)	(14)	(14) - (6)	(14) - (5+6)	(14) - (6)	(14) - (6+6)	(14) - (5+6+6)		
1621	560	13	(13)	(13)	(13) - (6)	(13) - (5+6)	(13) - (6)	(13) - (6+6)	(13) - (5+6+6)		
630	630	15	(14)	(14)	(14) - (6)	(14) - (5+6)	(14) - (6)	(14) - (6+6)	(14) - (5+6+6)		
1622	560	13	(13)	(13)	(13) - (6)	(13) - (5+6)	(13) - (6)	(13) - (6+6)	(13) - (5+6+6)		
630	630	15	(14)	(14)	(14) - (6)	(14) - (5+6)	(14) - (6)	(14) - (6+6)	(14) - (5+6+6)		
1624	560	13	(13)	(13)	(13) - (6)	(13) - (5+6)	(13) - (6)	(13) - (6+6)	(13) - (5+6+6)		
630	630	15	(14)	(14)	(14) - (6)	(14) - (5+6)	(14) - (6)	(14) - (6+6)	(14) - (5+6+6)		
1625	630	15	(14)	(14)	(14) - (6)	(14) - (5+6)	(14) - (6)	(14) - (6+6)	(14) - (5+6+6)		

Casing

General

The casing of 39GNS units is formed by:

- extruded aluminium perimeter frame, inner post and intermediate post.
- removable and fixed panels
- internal insulation

All external panels are Colorbond® XMA (ABR) steel.

Frames

The frame is made up of 4 components (Figure 3)

1. Extruded aluminium frame
2. Composite corner piece
3. Extruded Internal post
4. Extruded Intermediate post

1. Extruded Aluminium Frame

Forms the overall shape of the section and receives the panels. The extruded aluminium frame is manufactured from extrusion process using aluminium Grade 6063 -T5) with mill finish 1.5 mm thickness

2. Composite Material Corner Piece Trilegs

The composite corner piece is composed of Nylon 66 +33%GF (25mm casing) and Nylon 6 +30 %GF (50 mm casing) with fine finish surface and it is black in color.

3. Extruded Inner Post

Extruded aluminium inner post within the extruded aluminium frame increase the structural rigidity and provide a fixing point for an air-tight sealing strip.

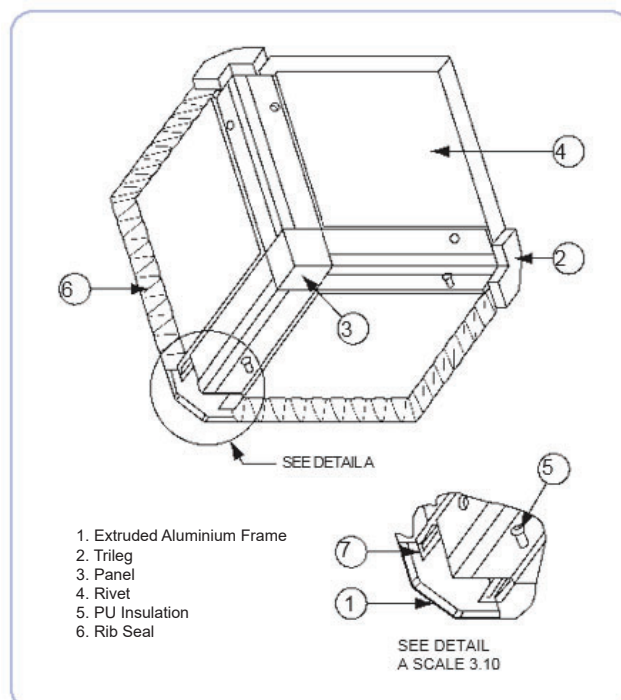

▲ Figure 3 Cross Section of Panels, Rib-Seal and Others

Panels

1.Fixed Panels

Forms the insulated enclosure of the casing and giving it rigidity and air- tightness, they consist of :

- external sheet metal
- insulation
- internal protective cover

The Colorbond @XMA (ABR) steel sheet with 26 Gauge thickness and the galvanized steel inner casing (26 Gauge) form double wall construction with PU insulation between the inner and the outer panel. Rivets are used to a fixed panel to AHU framework.

Optional : Wrap-around gasket (Figure 4) to replace rob - seal for enhancement of insulation on the aluminium frames to prevent condensation start on aluminium frames which should be suitable to units with ducted return application. It has shown that with wrap - around gasket on frames, it will on condensation at high humidity ambient.

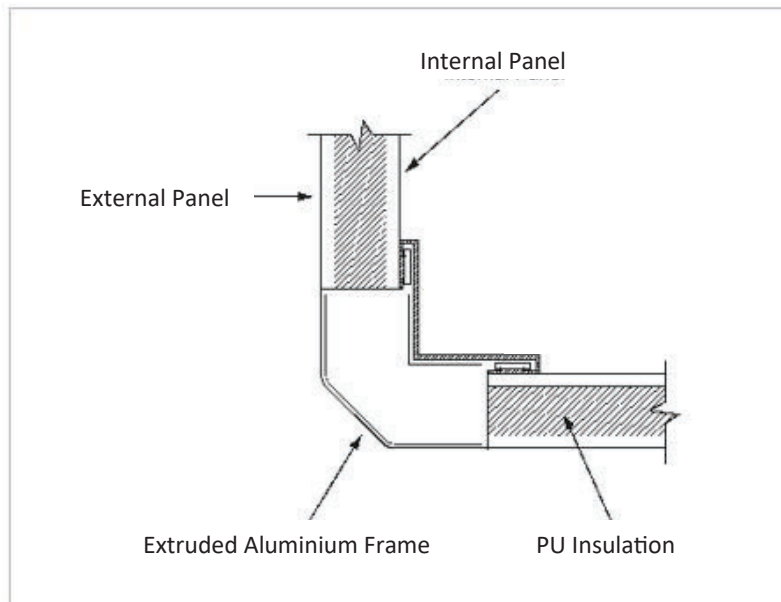

▲ Figure 4 Cross Section of Panel and Framework

2. Removable Access Panel

Are constructed of the same material as the fixed panels.

The access panel shall be low leak construction with a hex socket compression type latch assembly and large & non - conductive handles for easy removal of the access panel . (Figure 5 for Cross Section of Latch Assy.)

The removable /access panel shall be double skinned construction and internally insulated with injected insitu CFC- Free Polyurethane insulation. The access panel mating surface perimeter shall be lined with Rib-Seals.

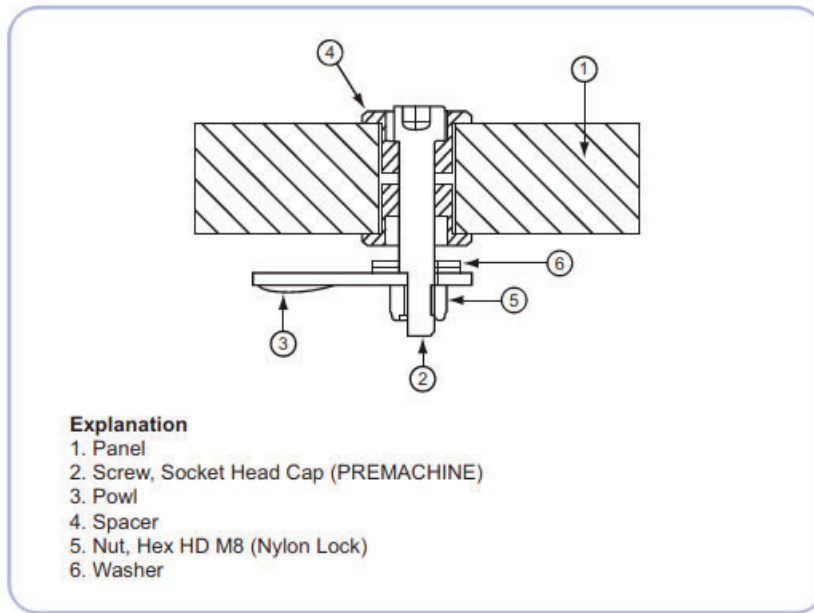

▲ Figure 5 Cross Section of Latch Assy

3.COLORBOND ® XMA (ABR) pre-painted steel.

Panels made from BHP COLORBOND ®XMA (ABR) steel provide excellent corrosion resistance and are beware outdoor durability. The substrate, ZINCALUME® zinc/aluminium alloy-coated steel complies with AS1397-1993 and the paint coating complies with AS/NZS 2728-1997.

Below are the specifications of COLORBOND ® XMA (ABR) steel.

Pretreatment -Corrosion resistant proprietary conversion coating.

Primer Coat -Universal corrosion inhibitive primer.Nominal thickness 5 µm top side.

Finish Coat -Custom formulated system.Nominal thickness 20µm top side in white color.

Insulation

The panels are frames and thermally insulated. The panels shall be constructed such that they shall comprise of two layers of steel sheet with injected insitu CFC-Free polyurethane insulation with thermal conductivity factor of 0.019 w/mK and density at least 40 kg/m³ in between.

BASE UNIT CASING WEIGHT

Table below shows the base unit casing weight for 50 mm. NTB casing

Unit Size	Fan	39GNS - 50 mm. Panel (kg.)						
		Fan		Coil		Filter	Acc.	MXB
		(HDT)	(VDT)	(HDT)	(VDT)			
0608	180	60	63	46	56	42	29	44
0609	180,200	71	68	49	59	43	30	47
0610	180,200	75	71	52	63	44	32	50
0711	200,225	84	82	57	70	50	35	56
0712	225,250	93	91	60	74	53	36	59
0811	225,250	94	94	58	73	54	36	59
0813	280,315	110	107	64	84	57	39	67
0912	250,280	110	109	64	85	61	40	66
0913	280,315	117	115	67	89	62	41	70
0914	315,355	126	118	69	92	65	43	73
1015	355,400	158	142	73	103	71	46	81
1016	355,400	162	152	76	107	72	47	86
1117	400,450	187	174	82	121	81	51	94
1317	400,450	201	179	85	131	86	54	102
1318	400,450	207	184	88	135	90	56	105
1418	450,500	232	209	93	143	96	57	119
1320	450,500	237	215	97	146	96	60	125
1518	450,500	240	212	94	147	100	58	123
1420	500,560	258	230	99	163	97	60	128
1322	500,560	260	236	102	166	102	62	133
1421	500,560	264	236	101	167	104	62	132
1422	500,560	270	241	105	173	106	64	137
1521	500,560	272	239	102	172	108	63	136
1522	560,630	293	271	106	183	111	65	142
1524	560,630	305	283	111	192	119	68	150
1525	560,630	319	291	116	199	121	71	157
1621	560,630	300	273	105	184	111	65	141
1622	560,630	307	279	109	190	113	66	146
1624	560,630	319	290	114	199	121	69	154
1625	560,630	330	296	119	206	124	72	161
1822	560,630	328	--	112	--	122	69	154
1824	630,710	352	--	120	--	131	71	162
1825	630,710	364	--	125	--	134	75	170
2025	630,710	388	--	134	--	140	77	213
2125	710,800	456	--	137	--	145	78	217
2226	710,800	476	--	140	--	154	81	228
2230	800,900	559	--	153	--	173	89	251
2330	800,900	573	--	158	--	179	90	257
2234	800,900	599	--	168	--	188	97	276
2334	800,900	614	--	174	--	194	98	282
2434	900,1000	644	--	172	--	200	99	287
2634	900,1000	675	--	177	--	205	102	299
2636	900,1000	693	--	183	--	217	105	312

39GNS - CHILLED WATER COIL WEIGHT

Unit Size	No. of rows		Chilled Water Coil																						
	3 rows			4 rows			5 rows			6 rows			7 rows			8 rows									
	8	10	12	14	8	10	12	14	8	10	12	14	8	10	12	14	8	10	12	14					
FPI	Dry Coil Weight (kg.)																								
Face Area (sq.ft.)																									
0608	2.77	19	19	20	21	22	22	23	24	25	25	26	27	27	28	29	31	31	32	34	33	34	35	37	
0609	3.26	21	21	22	23	24	25	25	27	27	28	29	31	30	31	32	34	34	35	36	38	37	38	40	42
0610	3.73	23	23	24	25	26	27	28	29	30	31	32	34	34	35	36	38	38	39	40	43	41	42	44	47
0711	4.81	27	28	29	30	32	33	34	36	37	38	39	42	41	43	44	47	46	48	50	53	51	53	55	59
0712	5.36	29	30	31	33	35	35	37	39	40	41	42	45	45	46	48	51	50	52	54	58	55	57	60	64
0811	6.01	33	34	35	36	39	40	41	43	45	46	48	51	50	52	54	58	56	58	61	65	62	64	67	72
0813	7.38	38	39	40	42	45	46	48	51	52	54	56	59	59	61	63	68	66	69	71	76	73	76	79	85
0912	7.37	38	39	40	43	45	46	48	51	52	54	56	60	59	61	64	68	67	69	72	77	74	76	80	85
0913	8.12	41	42	43	45	49	50	52	55	56	58	60	64	64	66	69	74	72	75	78	83	80	83	86	93
0914	8.88	43	45	46	49	52	53	55	59	60	62	65	69	69	71	74	79	78	80	84	90	86	89	93	100
1015	11.38	53	55	57	60	64	66	68	73	75	77	80	86	86	89	93	99	97	100	104	112	108	112	117	125
1016	12.26	56	58	60	63	68	70	73	77	80	82	86	92	91	95	98	106	103	107	111	120	115	119	124	134
1117	14.77	68	70	72	77	82	84	88	93	96	99	103	110	110	114	119	127	124	129	134	144	138	144	150	161
1317	17.72	80	82	85	90	97	100	104	110	114	117	122	131	130	135	141	151	147	153	159	171	164	171	178	192
1318	18.94	84	86	89	95	102	105	109	116	120	124	129	138	138	143	149	160	156	162	169	182	174	181	189	203
1418	19.99	88	91	94	100	107	110	115	123	126	130	136	145	145	150	157	168	164	170	178	191	183	190	199	214
1320	21.41	92	94	98	104	112	116	120	128	132	137	142	153	152	158	165	177	173	179	187	202	193	200	210	226
1518	22.09	96	99	103	109	117	121	126	134	138	143	149	160	159	165	172	185	180	187	195	210	201	209	218	236
1420	22.60	96	99	103	109	118	122	126	135	139	144	150	161	160	166	174	187	182	189	197	212	203	211	221	238
1322	23.88	100	103	106	113	122	126	131	141	145	150	156	168	167	173	181	195	190	197	206	222	212	220	230	249
1421	23.88	100	104	107	114	123	127	132	141	146	151	157	169	168	175	182	196	191	198	207	223	213	222	232	250
1422	25.20	105	108	112	119	128	133	138	148	152	158	164	177	176	182	190	205	200	207	217	234	224	232	243	262
1521	26.40	113	116	120	128	138	142	148	158	163	168	175	188	187	194	203	218	213	221	230	248	237	247	258	278
1522	27.85	117	121	125	133	143	148	154	165	170	176	183	196	196	203	212	228	222	231	241	260	249	258	270	292
1524	30.73	126	130	135	144	155	160	167	179	184	191	199	213	213	221	231	248	242	251	262	283	271	281	294	318
1525	32.16	131	135	140	149	161	167	173	186	191	198	207	222	221	230	240	258	252	261	273	295	282	293	307	331
1621	27.65	--	--	--	--	144	149	154	165	170	176	183	197	196	203	212	228	222	231	241	260	248	258	270	291
1622	29.18	--	--	--	--	150	155	161	172	177	184	191	205	205	213	222	239	232	241	252	272	260	270	283	305
1624	32.20	--	--	--	--	162	168	174	187	192	199	208	223	223	231	241	260	253	263	275	296	283	294	308	333
1625	33.69	--	--	--	--	168	174	181	194	200	207	216	232	231	240	251	270	263	273	286	308	295	306	321	346
1822	33.16	--	--	--	--	169	175	182	194	200	207	216	232	231	240	250	270	262	273	285	307	294	305	319	345
1824	36.59	--	--	--	--	182	189	196	210	217	225	234	252	251	261	272	293	286	297	310	335	320	333	348	376
1825	38.28	--	--	--	--	189	196	204	218	225	233	244	262	261	271	283	305	297	309	323	349	333	346	363	392
2025	42.88	--	--	--	--	219	227	236	252	260	269	280	301	300	311	325	349	340	353	369	398	380	395	413	446
2125	44.41	--	--	--	--	226	234	243	260	268	278	289	311	310	321	335	361	351	365	381	411	393	408	427	461
2226	49.57	--	--	--	--	253	262	272	291	300	311	324	348	347	359	375	404	393	408	426	460	440	457	478	516
2230	58.07	--	--	--	--	289	299	311	333	343	356	371	399	398	413	431	464	452	469	491	530	506	526	551	595
2330	59.94	--	--	--	--	297	308	320	343	353	366	382	411	409	425	444	478	465	483	505	546	521	542	567	613
2234	66.52	--	--	--	--	325	336	350	375	387	401	418	450	449	466	487	525	511	531	555	600	573	596	624	674
2334	68.67	--	--	--	--	334	346	360	386	398	413	431	463	462	480	501	541	526	547	572	618	590	614	643	695
2434	72.96	--	--	--	--	353	365	380	408	421	436	455	490	489	507	530	572	557	579	606	654	625	650	680	736
2634	79.40	--	--	--	--	380	394	411	441	454	472	492	530	529	549	574	619	603	626	656	709	677	704	737	798
2636	84.47	--	--	--	--	401	416	433	466	480	498	520	560	558	580	607	655	637	663	694	750	716	745	780	845

Note : - All coils are 12.7 mm.OD copper tubes with aluminum plated fin construction
 - To estimate the weight of water content (kg) use : Face area (sq.ft.) x no of rows x 0.65 kg/sq.ft. ()
 - To estimate dry coil weight (kg) for copper plate fin construction, use the above data (kg) x 3.3

Fan

1. Fan Laws

For a given distribution system and specific air weight, the following laws in relation to volume, pressure and fan power applied dependent upon fan speed.

- The volume (V) changes as the fan speed (n) changes

$$V_2 = V_1 \frac{n_2}{n_1}$$

- The pressure (p) changes with the square of the speed (n)

$$P_2 = P_1 \left(\frac{n_2}{n_1} \right)^2$$

- The absorbed power (Pw) changes with the cube of the speed (n)

$$PW_2 = PW_1 \left(\frac{n_2}{n_1} \right)^3$$

- As the specific weight of the air changes, the air quantities remain constant.

- The pressure and the absorbed power change with the specific weight.

$$P_2 = P_1 \frac{y_2}{y_1} \quad \text{and} \quad PW_2 = PW_1 \frac{y_2}{y_1}$$

2. Reference Values

The fan curves refer to a specific weight of 1.2 kgf/m³ at a temperature of 20°C at atmospheric pressure of 1013 kPa (760mm Hg) and a relative humidity of 50%.

Description

1.Type of Fans

39GNS air handling units are supplied with double inlet, double width (DIDW)centrifugal blowers of either : and other type for optional

- I) Forward curved (FC) Certrifugal DIDW forward curved.
- II) Backward curved (BC) Certrifugal DIDW backward curved.
- III) Backward curved (BC) Certrifugal SISW forward curved (optional).
- IV) Backward curved (BC) Certrifugal SISW backward curved (optional).
- V) Backward curved (BC) Plug fan(optional).
- VI) Backward curved (BC) EC fan (optional).

2.Construction

- a) Fan casings are constructed of galvanized steel with a series of punched holes or nutserts allowing the fixing of accessories such as frames or support legs thus providing a variety of discharge positions .
- b) The impeller is galvanized finished for forward curved fan and epoxy painted for backward curved and securely fixed to the shaft. (bored & keywayed)Backward curved fan has lower energy consumption due to its high performance impeller with welded true aerofoil blades inclined obliquely to the shaft axis. All fan impellers are statically and dynamically balanced to the operating fan speed as shown in the equipment schedule in accordance with ISO 1940 Part 1.Quality level G 2 .5.
- c) Shafts are trued in accordance with DIN 748.Toleranz class g6
- d) Deep groove ball bearings are supplied for smaller fan size.Self aligning Single row ball bearings mounted with a cast iron housing (real plummer block bearing)for size 400-1000.All bearings are pre -lubricated from the factory. Higher life expectancy bearings are available as option.

Recommendations

The air to be handled in the unit must be clean, and noncorrosive.

Each air handling unit can have a choice of several fan type with best efficiency and lowest sound level should be selected for a specific installation.

Fan Length

39GNS UNIT SIZE	Fan Size	FC (Frame)*		BC (Frame)**		Range of Motor HP	Discharge Type	Fan Size	Fan Length (Modules)		Vertical Unit Height in Module
		C	T	C	T				HDT	VDT	
0608	180	●				1.5 - 2	UBF, UBR, THF, BHF, THR, BHR, DBR, DBF	180	6	8	6
0609	180, 200	●				1.5 - 3	UBF, UBR, THF, BHF, THR, BHR, DBR, DBF	180 200	6 7	8 8	6
0610	180, 200	●				1.5 - 3	UBF, UBR, THF, BHF, THR, BHR, DBR, DBF	180 200	5 7	8 8	6
0711	200, 225	●	●			1.5 - 5	UBF, UBR, THF, BHF, THR, BHR, DBR, DBF	200 225	7 7	8 8	7
0712	225, 250	●	●	●	●	2 - 5	UBF, UBR, THF, BHF, THR, BHR, DBR, DBF	225 250	7 7	8 8	7
0811	225, 250	●	●	●	●	2 - 5	UBF, UBR, THF, BHF, THR, BHR, DBR, DBF	225 250	7 7	8 8	8
0813	280, 315	●	●	●	●	3 - 7.5	UBF, UBR, THF, BHF, THR, BHR, DBR, DBF	280 315	8 8	9 9	8
0912	250, 280	●	●	●	●	2 - 7.5	UBF, UBR, THF, BHF, THR, BHR, DBR, DBF	250 280	7 8	8 9	9
0913	280, 315	●	●	●	●	3 - 7.5	UBF, UBR, THF, BHF, THR, BHR, DBR, DBF	280 315	8 8	9 9	9
0914	315, 355	●	●	●	●	4 - 15	UBF, UBR, THF, BHF, THR, BHR, DBR, DBF	315 355	8 9	9 9	9
1015	355, 400	●	●	●	●	4 - 15	UBF, UBR, THF, BHF, THR, BHR, DBR, DBF	355 400	9 10	9 10	9
1016	355, 400	●	●	●	●	4 - 15	UBF, UBR, THF, BHF, THR, BHR, DBR, DBF	355 400	9 10	9 10	9
1117	400, 450	●	●	●	●	5 - 15	UBF, UBR, THF, BHF, THR, BHR, DBR, DBF	400 450	10 11	10 11	10
1317	400, 450	●	●	●	●	5 - 15	UBF, UBR, THF, BHF, THR, BHR, DBR, DBF	400 450	10 11	10 11	10
1318	400, 450	●	●	●	●	5 - 15	UBF, UBR, THF, BHF, THR, BHR, DBR, DBF	400 450	10 11	10 11	10
1320	450, 500	●	●	●	●	7.5 - 15	UBF, UBR, THF, BHF, THR, BHR, DBR, DBF	450 500	11 11	11 11	11
1322	500, 560	●	●	●	●	10 - 20	UBF, UBR, THF, BHF, THR, BHR, DBR, DBF	500 560	11 13	11 13	12
1418	450, 500	●	●	●	●	7.5 - 15	UBF, UBR, THF, BHF, THR, BHR, DBR, DBF	450 500	11 11	11 11	11
1420	500, 560	●	●	●	●	10 - 20	UBF, UBR, THF, BHF, THR, BHR, DBR, DBF	500 560	11 13	11 13	12
1421	500, 560	●	●	●	●	10 - 20	UBF, UBR, THF, BHF, THR, BHR, DBR, DBF	500 560	11 13	11 13	12
1422	500, 560	●	●	●	●	10 - 20	UBF, UBR, THF, BHF, THR, BHR, DBR, DBF	500 560	11 13	11 13	12
1518	450, 500	●	●	●	●	7.5 - 15	UBF, UBR, THF, BHF, THR, BHR, DBR, DBF	450 500	11 11	11 11	11
1521	500, 560	●	●	●	●	10 - 20	UBF, UBR, THF, BHF, THR, BHR, DBR, DBF	500 560	11 13	11 13	12
1522	560, 630	●	●	●	●	10 - 20	UBF, UBR, THF, BHF, THR, BHR, DBR, DBF	560 630	13 14	13 14	13 15

Fan Length

39GNS UNIT SIZE	Fan Size		FC (Frame)*		BC (Frame)**		Range of Motor HP	Discharge Type	Fan Size	Fan Length (Modules)		Vertical Unit Height in Module
	C	T	C	T	HDT	VDT						
1524	560, 630	●	●	●	●	●	10 - 20	UBF, UBR, THF, BHF, THR, BHR, DBR, DBF	560 630	13 14	13 14	13 15
1525	560, 630	●	●	●	●	●	10 - 20	UBF, UBR, THF, BHF, THR, BHR, DBR, DBF	560 630	13 14	13 14	13 15
1621	560, 630	●	●	●	●	●	10 - 25	UBF, UBR, THF, BHF, THR, BHR, DBR, DBF	560 630	13 14	13 14	13 15
1622	560, 630	●	●	●	●	●	10 - 25	UBF, UBR, THF, BHF, THR, BHR, DBR, DBF	560 630	13 14	13 14	13 15
1624	560, 630	●	●	●	●	●	10 - 25	UBF, UBR, THF, BHF, THR, BHR, DBR, DBF	560 630	13 14	13 14	13 15
1625	560, 630	●	●	●	●	●	10 - 25	UBF, UBR, THF, BHF, THR, BHR, DBR, DBF	560 630	13 14	13 14	13 15
1822	560, 630	●	●	●	●	●	10 - 25	UBF, UBR, THF, BHF, THR, BHR, DBR, DBF	560 630	13 14	-	-
1824	630, 710	●	●	●	●	●	15 - 30	UBF, UBR, THF, BHF, THR, BHR, DBR, DBF	630 710	14 15	-	-
1825	630, 710	●	●	●	●	●	15 - 30	UBF, UBR, THF, BHF, THR, BHR, DBR, DBF	630 710	14 15	-	-
2025	630, 710	●	●	●	●	●	15 - 30	UBF, UBR, THF, BHF, THR, BHR, DBR, DBF	630 710	14 15	-	-
2125	710, 800	●	●	●	●	●	20 - 40	UBF, UBR, THF, BHF, THR, BHR, DBR, DBF	710 800	15 17	-	-
2226	710, 800	●	●	●	●	●	20 - 40	UBF, UBR, THF, BHF, THR, BHR, DBR, DBF	710 800	15 17	-	-
2230	800, 900		●		●	●	25 - 50	UBF, UBR, THF, BHF, THR, BHR, DBR, DBF	800 900	17 19	-	-
2234	800, 900		●		●	●	25 - 60	UBF, UBR, THF, BHF, THR, BHR, DBR, DBF	800 900	17 19	-	-
2330	800, 900		●		●	●	25 - 60	UBF, UBR, THF, BHF, THR, BHR, DBR, DBF	800 900	17 19	-	-
2334	800, 900		●		●	●	25 - 60	UBF, UBR, THF, BHF, THR, BHR, DBR, DBF	800 900	17 19	-	-
2434	900, 1000		●		●	●	25 - 60	UBF, UBR, THF, BHF, THR, BHR, DBR, DBF	900 1000	19 20	-	-
2634	900, 1000		●		●	●	25 - 75	UBF, UBR, THF, BHF, THR, BHR, DBR, DBF	900 1000	19 20	-	-
2636	900, 1000		●		●	●	25 - 75	UBF, UBR, THF, BHF, THR, BHR, DBR, DBF	900 1000	19 20	-	-

Remark :

FC : Forward curved

BC : Backward curved

BHR and THR is only a valid option for vertical units.

DBF and DBR is only a valid option for horizontal units.

For discharge type DBF, DBR (for HDT), fan length must be longer approx. 2 modules

Limited fan size for DBF, DBR up to fan size 450 only.

Forward Curved , Backward Curved Fan Shaft Diameter

Fan Size	Diameter (mm) Drive / Blower Side (tolerances)
FC	
FC - 180	20 g6
FC - 200	20 g6
FC - 225	20 g6
FC - 250	20 g6
FC - 280	25 g6
FC - 315	25 g6
FC - 355	30 g6
FC - 400	30 g6
FC - 450	35 g6
FC - 500	35 g6
FC - 560	40 g6
FC - 630	40 g6
FC - 710	50 g6
FC - 800	55 g6
FC - 900	60 g6
FC - 1000	60 g6
BC	
BC - 225	20 g6
BC - 250	20 g6
BC - 280	25 g6
BC - 315	25 g6
BC - 355	30 g6
BC - 400	30 g6
BC - 450	35 g6
BC - 500	35 g6
BC - 560	40 g6
BC - 630	40 g6
BC - 710	50 g6
BC - 800	55 g6
BC - 900	60 g6
BC - 1000	60 g6

Fan Housing Dimension and Weight

Table below shows full details of 39GNS fan housing dimension and weight.

Fan Size	Length (mm)	Width (mm)	Height (mm)	Weight (kg)
Forward Curved				
FC - 180	323	268	336	8
FC - 200	343	306	370	10
FC - 225	382	338	415	12
FC - 250	418	372	460	17
FC - 280	466	420	518	20
FC - 315	518	464	578	24
FC - 355	578	532	654	32
FC - 400	650	586	736	41
FC - 450	726	648	827	51
FC - 500	800	718	918	74
FC - 560	892	814	1030	93
FC - 630	998	900	1157	104
FC - 710	1120	998	1302	192
FC - 800	1254	1100	1468	240
FC - 900	1408	1230	1648	293
FC - 1000	1540	1366	1810	340
Backward Curved				
BC - 225	366	350	433	15
BC - 250	418	372	460	19
BC - 280	466	420	518	24
BC - 315	518	464	578	28
BC - 355	578	532	654	41
BC - 400	650	586	736	49
BC - 450	726	648	827	65
BC - 500	800	718	918	83
BC - 560	892	814	1030	110
BC - 630	998	900	1157	141
BC - 710	1120	998	1302	251
BC - 800	1254	1106	1468	299
BC - 900	1408	1230	1648	368
BC - 1000	1540	1366	1810	474

Note : Width does not include both end of shaft.

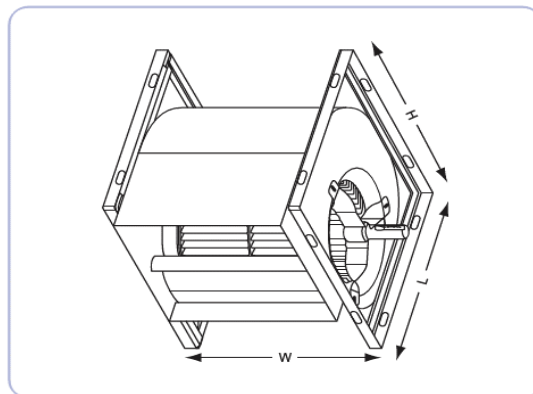

Fan Motor Weight

Table below shows the approximate fan motor weight.

Motor HP	Motor kW	Approx. Weight (kg)	Frame Number
1	0.75	17	D80
1.5	1.1	25	D90S
2	1.5	26	D90L
3 & 4	2.2/3.0	35	D100L
5 & 5 1/2	3.7/4.4	47	D112M
7.5	5.5	68	D132S
10	7.5	79	D132M
15	11	122	D160M
20	15	144	D160L
25	18.5	189	D180M
30	22	203	D180L
40	30	290	D200L
50	37	320	D225SC
60	45	355	D225MC
75	55	381	D250SA

Note : • Motor weights based on 4 - pole 380/3Ø/50Hz induction type TEFC motor foot mounted.

• Motor shall be of , Y or D.O.L wiring.

• Standard motor shall be per IEE standard IP55 enclosure with Class F, IE2 (high efficiency) insulation and Class B Temperature rise complying with BS2757.

• Maximum ambient temperature 45°C.

• For derivation of motor kW from fan BkW use:

Motor kW = Fan BkW x A, where A = 1.20 if BkW < 10 kW

A = 1.15 if BkW > 10 kW

• Please refer to your nearest Carrier Representatives for special motor voltages or application.

Fan Size and RPM Limitation/BkW Limitation

Fan Type	Fan Size	Maximum RPM	Maximum Absorbed Power kw
Forward Curved	FC - 180	4000	2
	FC - 200	3200	2
	FC - 225	2900	3
	FC - 250	2700	3
	FC - 280	2400	4
	FC - 315	2100	5.5
	FC - 355	1800	5.5
	FC - 400	1600	7.5
	FC - 450	1400	7.5
	FC - 500	1200	11
	FC - 560	1100	11
	FC - 630	900	15
	FC - 710	850	22
	FC - 800	750	22
	FC - 900	650	30
FC - 1000	600	37	
Backward Curved	BC - 225	6640	4
	BC - 250	4000	4
	BC - 280	4000	4
	BC - 315	3500	5
	BC - 355	3000	7.5
	BC - 400	2700	7.5
	BC - 450	2300	11
	BC - 500	2100	11
	BC - 560	1800	15
	BC - 630	1500	15
	BC - 710	1500	18.5
	BC - 800	1300	22
	BC - 900	1200	30
	BC - 1000	1050	37

Remark : A selection is valid provided it first reaches and not exceed either max. limits (RPM of BkW).

: Above data base or

- FC 180 - 70 Type C
- FC 800 - 1,000 Type T
- BC225 - 710 Type C
- BC800 - 1,000 Type T

Filter

General

The types of filters offered in 39GNS are as follows

- i) HVF - High velocity filters
- ii) BF - Bag filters
- iii) HEPA Filter

Each filter type selected shall include a 39GNS section with the appropriate tracks. The filter section shall be similar in construction as the other 39GNS sections. The tracks supplied shall be in accordance to the HVAC filter standard sizes and its gravimetric efficiency per ASHRAE 52-76.

High Velocity Filter (HVF)

Commonly known as pre-filter, the HVF is offered with a thickness of either 25mm or 50mm. The standard gravimetric efficiency shall be 85% with 70% optional and media are washable made of aluminum or synthetic fiber. The HVF can be installed to the 39GNS as follows

- i) Front loading with track only (i.e. free return application)
- ii) Front loading/withdrawal filter track within 2 module length section. When require filter section which must be able to accessible for filter loading/withdrawal by access door at return duct (i.e. duct return application) or access door at mixing box.

The frames and tracks are fabricated of 1.25 mm (18 gauge) thick galvanized steel sheet.

Bag Filter (BF)

The bag filter is normally used as 2nd stage filtration media. The factory standard efficiency shall be 95% gravimetric efficiency. Media are disposable type. The bag filter media shall be synthetic fiber of 300- 600 mm. bag length and 25 mm. thick aluminum frame

As a standard, the BF section comprises of 6 module, by front loading/withdrawal method.

Friction Pressure Drop

Due to filter media resists to the air flow resulting in static loss, therefore refer to Table 23 on the respective static pressure loss against velocity (interpolation is permissible).

Filter Pressure Drop (Pa)

Filter Face Velocity (m/s)	1.5	2.0	2.5	3.0	3.5
HVF 2" thick 85% gravimetric	8.96	12.46	19.93	27.40	37.40
BF 600mm bag length 95%gravimetric	9.96	14.95	29.89	47.33	69.75

Note: Data shown is for clean filter, based on synthetic fiber material. The normal allowable pressure drop for dirty filter should not exceed 300Pa (1.2" WG).

High efficiency particulate air

HEPA is a type of pleated mechanical air filter. It is an acronym for "high efficiency particulate air [filter]" (as officially defined by the U.S. Dept. of Energy). This type of air filter can theoretically remove at least 99.97% of dust, pollen, mold, bacteria, and any airborne particles with a size of 0.3 microns (µm). The diameter specification of 0.3 microns responds to the worst case; the most penetrating particle size (MPPS). Particles that are larger or smaller are trapped with even higher efficiency. Using the worst case particle size results in the worst case efficiency rating (i.e. 99.97% or better for all particle sizes).

All air cleaners require periodic cleaning and filter replacement to function properly. Follow manufacturer's recommendations on maintenance and replacement.

Minimum Efficiency Reporting Values, or MERVs, report a filter's ability to capture larger particles between 0.3 and 10 microns (µm).

- This value is helpful in comparing the performance of different filters
- The rating is derived from a test method developed by the American Society of Heating, Refrigerating, and Air Conditioning Engineers (ASHRAE) [see www.ashrae.org].
- The higher the MERV rating the better the filter is at trapping specific types of particles.

MERV Rating	Average Particle Size Efficiency in Microns
1-4	3.0 - 10.0 less than 20%
6	3.0 - 10.0 49.9%
8	3.0 - 10.0 84.9%
10	1.0 - 3.0 50% - 64.9%, 3.0 - 10.0 85% or greater
12	1.0 - 3.0 80% - 89.9%, 3.0 - 10.0 90% or greater
14	0.3 - 1.0 75% - 84%, 1.0 - 3.0 90% or greater
16	0.3 - 1.0 75% or greater

39GNS : SIZE & QUANTITY OF FILTER

No.	39G	No. of Filter Usage				Fig.
		20-x20-x2- (495 X 495)	10-x20-x2- (238 X 495)	24-x24-x2- (595 X 595)	12-x24-x2- (289 X 595)	
1	0608	-	2	-	-	Fig. 1
2	0609	1	1	-	-	Fig. 2
3	0610	1	1	-	-	Fig. 2
4	0711	-	-	1	1	Fig. 2
5	0712	-	-	1	1	Fig. 2
6	0811	-	-	1	1	Fig. 2
7	0813	-	-	2	-	Fig. 3
8	0912	-	-	1	1	Fig. 2
9	0913	-	-	2	-	Fig. 2
10	0914	-	-	2	-	Fig. 2
11	1015	-	-	2	2	Fig. 4
12	1016	-	-	2	3	Fig. 5
13	1117	-	-	2	3	Fig. 5
14	1317	-	-	4	2	Fig. 6
15	1318	-	-	4	2	Fig. 6
16	1320	-	-	6	-	Fig. 7
17	1418	-	-	4	2	Fig. 6
18	1518	-	-	4	2	Fig. 6
19	1420	-	-	6	-	Fig. 7
20	1322	-	-	6	2	Fig. 8
21	1421	-	-	6	-	Fig. 7
22	1422	-	-	6	2	Fig. 8
23	1521	-	-	6	-	Fig. 7
24	1621	-	-	6	3	Fig. 9
25	1522	-	-	6	2	Fig. 8
26	1622	-	-	6	5	Fig. 10
27	1524	-	-	6	2	Fig. 8
28	1525	-	-	8	-	Fig. 11
29	1624	-	-	6	5	Fig. 10
30	1625	-	-	8	4	Fig. 12
31	1822	-	-	6	5	Fig. 10
32	1824	-	-	6	5	Fig. 10
33	1825	-	-	8	4	Fig. 12
34	2025	-	-	12	-	Fig. 13
35	2125	-	-	12	-	Fig. 13
36	2226	-	-	12	4	Fig. 14
37	2230	-	-	12	7	Fig. 15
38	2330	-	-	12	7	Fig. 15
39	2234	-	-	15	8	Fig. 16
40	2334	-	-	15	8	Fig. 16
41	2434	-	-	15	8	Fig. 16
42	2634	-	-	20	4	Fig. 17
43	2636	-	-	20	4	Fig. 17

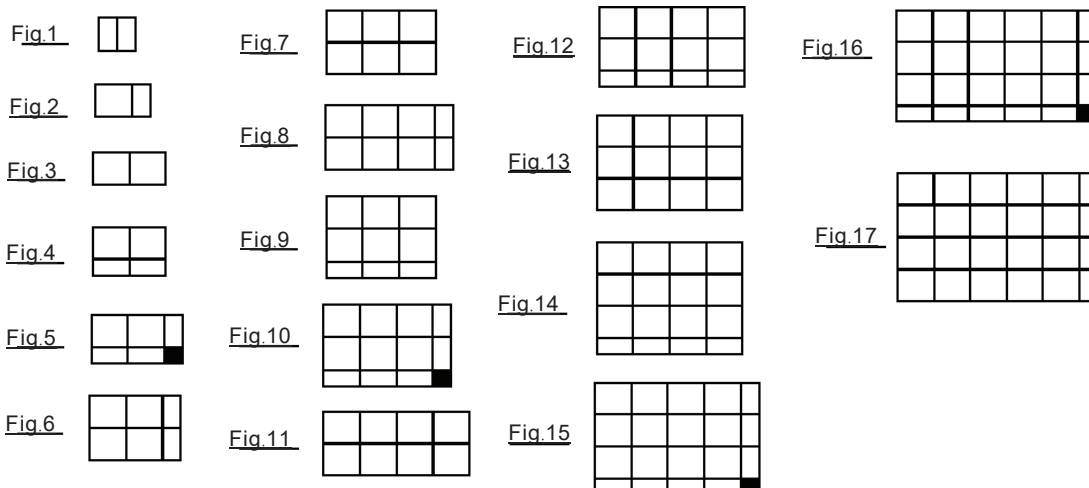

Mixing Box

Mixing box shall have volum damper as optional interconnected opposing action between outdoor air and return air dampers. Dampers blades shall be brake formed for stiffness and shall be spot welded to a 13mm O.D. steel rods rotating in nylon bushings press-seated in rigid damper frames. Damper shall be fabricated from 1.2mm (18 gauge) thick galvanized steel sheet and the damper frame of 1.2 mm (18 gauge)

Dampers shall be sectionalized to limit blade length to not more than 1526 mm in order to prevent excessive blade warping and ensure tight closure. Outdoor air and return air dampers shall be of the same area

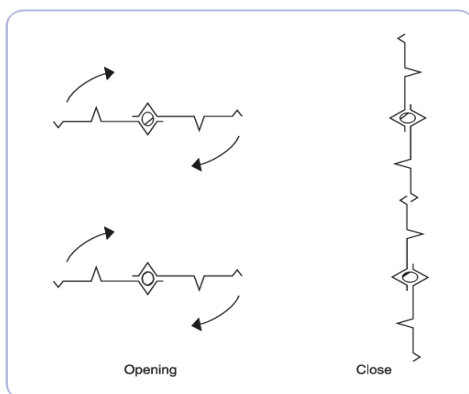

Air leakage using damper area ration and a perimeter gap of 3 mm between blade and frame results in leakage rate of approximately 3% as a complete system when either one damper assembly is completely closed.

The damper are located on the outside of mixing boxes and the standard damper location shall be top and rear. Interconnection between outdoor air and return air damper is made with push rods installed in the factory. The damper blades for each assembly shall be connected using linkages on one side of the damper frames ensuring its synchronous movement.

The damper frame is U-formed /flanged but not drilled which serves as a flange or duct work connection. Low leakage demper is avialable as option.

Mixing Box Section in Module

Unit Size 39 GNS	Horizontal Module Length (M)	Vertical Module Length (M)
0608-1318	5M	5M
1418-1625	6M	6M
1822-1825	6M	-
2025-2636	9M	-

Mixing Box Dampers Friction Loss

Section	Velocity(m/s)					
	150	200	250	300	350	400
Mixing Box(Pa)	249	498	996	12.46	14.95	19.93

Accessories (Optional)

UV Lamps

In response to the current coronavirus epidemic situation, sterilization option using UltraViolet (UV) is available for FCU products.

UV light for kill germs in a wide range of wavelengths between 200 to 400 (nm) which is highly effective in killing bacteria and reduces the formation of viruses by breaking down the molecular bonds that hold their DNA and RNA together.

UV-C at this wavelength ,Is the wavelength that DNA can absorb well can be punched and disabled their growth. By destroying their DNA sequence When doing this, the virus will lose their ability to reproduce.

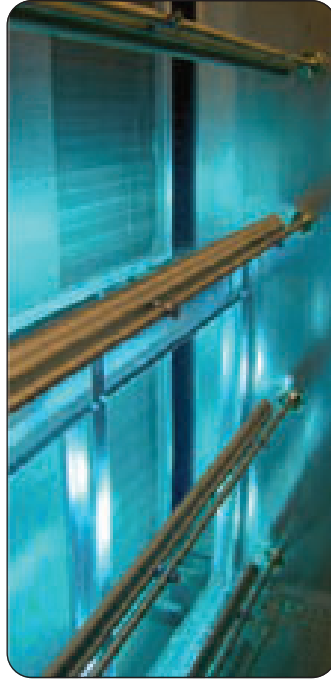

UV-C rays are not found in nature because these rays cannot passthrough the ozone layer to the earth's surface. The use of this type of radiation to destroy the infection requires a source of radiation. Including mercury lamps.

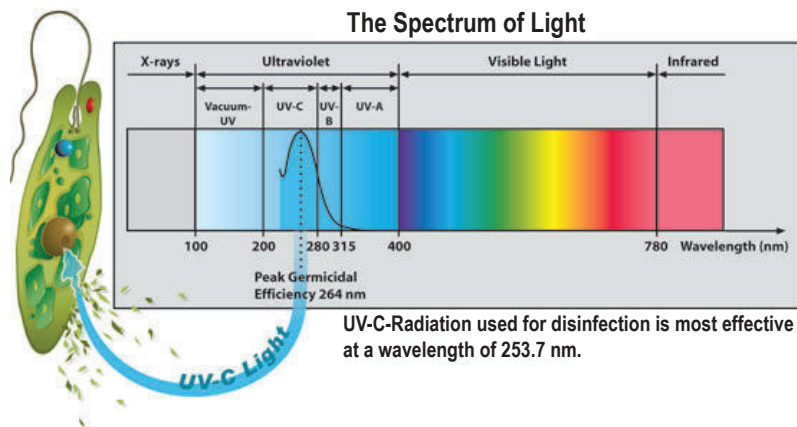

Advantages of UV-C lamp

- 253.7nm UV-C lamp, no generate ozone.
- High-energy UV-C, effective life is up to 8000 hours.
- Stainless steel reflector enhances the radiation intensity and avoids direct exposure to the human body.
- Plug-in products for easy installation.
- External control box, 220VAC standard power supply, simple wiring.
- Able to kill bacteria in the air and prevent the virus from spreading through the host bacteria

39GNS COIL (Cu. tube dia. 1/2" , Aluminium Fin) , CW Coil UVC Lamp length (mm.)

NO.	Coil 39GNS	Tubes / Row (1/2")	Fin Hight mm.	Fin Width mm.	Coil Face sq.ft.	Air Volume CFM	UVC Lamp	Q'ty	ความยาวหลอด mm.
1	0608	14	444.5	580.0	2.77	1,247	CUVC-A25LAMP	1	550
2	0609	14	444.5	680.0	3.26	1,466	CUVC-A25LAMP	1	550
3	0610	14	444.5	780.0	3.73	1,679	CUVC-A25LAMP	1	550
4	0711	16	508.0	880.0	4.81	2,163	CUVC-A25LAMP	1	550
5	0712	16	508.0	980.0	5.36	2,413	CUVC-A25LAMP	1	550
6	0811	20	635.0	880.0	6.01	2,703	CUVC-A25LAMP	1	550
7	0813	20	635.0	1,080.0	7.38	3,320	CUVC-A30LAMP	1	1,000
8	0912	22	698.5	980.0	7.37	3,317	CUVC-A30LAMP	1	1,000
9	0913	22	698.5	1,080.0	8.12	3,652	CUVC-A30LAMP	1	1,000
10	0914	22	698.5	1,180.0	8.88	3,996	CUVC-A30LAMP	1	1,000
11	1015	26	825.5	1,280.0	11.38	5,119	CUVC-A55LAMP	1	1,000
12	1016	26	825.5	1,380.0	12.26	5,515	CUVC-A55LAMP	1	1,000
13	1117	30	952.5	1,440.0	14.77	6,645	CUVC-A75LAMP	1	1,300
14	1317	36	1,143.0	1,440.0	17.72	7,973	CUVC-A30LAMP	2	1,000
15	1318	36	1,143.0	1,540.0	18.94	8,522	CUVC-A55LAMP	2	1,000
16	1418	38	1,206.5	1,540.0	19.99	8,995	CUVC-A55LAMP	2	1,000
17	1320	36	1,143.0	1,740.0	21.41	9,633	CUVC-A55LAMP	2	1,000
18	1518	42	1,333.5	1,540.0	22.09	9,942	CUVC-A55LAMP	2	1,000
19	1420	38	1,206.5	1,740.0	22.60	10,168	CUVC-A55LAMP	2	1,000
20	1322	36	1,143.0	1,940.0	23.88	10,744	CUVC-A55LAMP	2	1,000
21	1421	38	1,206.5	1,840.0	23.88	10,747	CUVC-A55LAMP	2	1,000
22	1422	38	1,206.5	1,940.0	25.20	11,341	CUVC-A55LAMP	2	1,000
23	1521	42	1,333.5	1,840.0	26.40	11,878	CUVC-A75LAMP	2	1,300
24	1522	42	1,333.5	1,940.0	27.85	12,534	CUVC-A75LAMP	2	1,300
25	1524	42	1,333.5	2,140.0	30.73	13,830	CUVC-A75LAMP	2	1,300
26	1525	42	1,333.5	2,240.0	32.16	14,470	CUVC-A75LAMP	2	1,300
27	1621	44	1,397.0	1,840.0	27.65	12,444	CUVC-A75LAMP	2	1,300
28	1622	44	1,397.0	1,940.0	29.18	13,131	CUVC-A75LAMP	2	1,300
29	1624	44	1,397.0	2,140.0	32.20	14,489	CUVC-A75LAMP	2	1,300
30	1625	44	1,397.0	2,240.0	33.69	15,159	CUVC-A75LAMP	2	1,300
31	1822	50	1,587.5	1,940.0	33.16	14,922	CUVC-A75LAMP	2	1,300
32	1824	50	1,587.5	2,140.0	36.59	16,465	CUVC-A55LAMP	4	1,000
33	1825	50	1,587.5	2,240.0	38.28	17,227	CUVC-A55LAMP	4	1,000
34	2025	28	889.0	2,240.0	42.88	19,294	CUVC-A55LAMP	4	1,000
		28	889.0	2,240.0					
35	2125	28	889.0	2,240.0	44.41	19,983	CUVC-A55LAMP	4	1,000
		30	952.5	2,240.0					
36	2226	30	952.5	2,340.0	49.57	22,305	CUVC-A55LAMP	4	1,000
		32	1,016.0	2,340.0					
37	2230	30	952.5	2,740.0	58.07	26,132	CUVC-A75LAMP	4	1,300
		32	1,016.0	2,740.0					
38	2330	32	1,016.0	2,740.0	59.94	26,975	CUVC-A75LAMP	4	1,300
		32	1,016.0	2,740.0					
39	2234	30	952.5	3,140.0	66.52	29,934	CUVC-A55LAMP	6	1,000
		32	1,016.0	3,140.0					
40	2334	32	1,016.0	3,140.0	68.67	30,900	CUVC-A55LAMP	6	1,000
		32	1,016.0	3,140.0					
41	2434	34	1,079.5	3,140.0	72.96	32,831	CUVC-A55LAMP	6	1,000
		34	1,079.5	3,140.0					
42	2634	36	1,143.0	3,140.0	79.40	35,728	CUVC-A55LAMP	6	1,000
		38	1,206.5	3,140.0					
43	2636	36	1,143.0	3,340.0	84.47	38,012	CUVC-A75LAMP	6	1,300
		38	1,206.5	3,340.0					

UV Lamp 39GNS Series

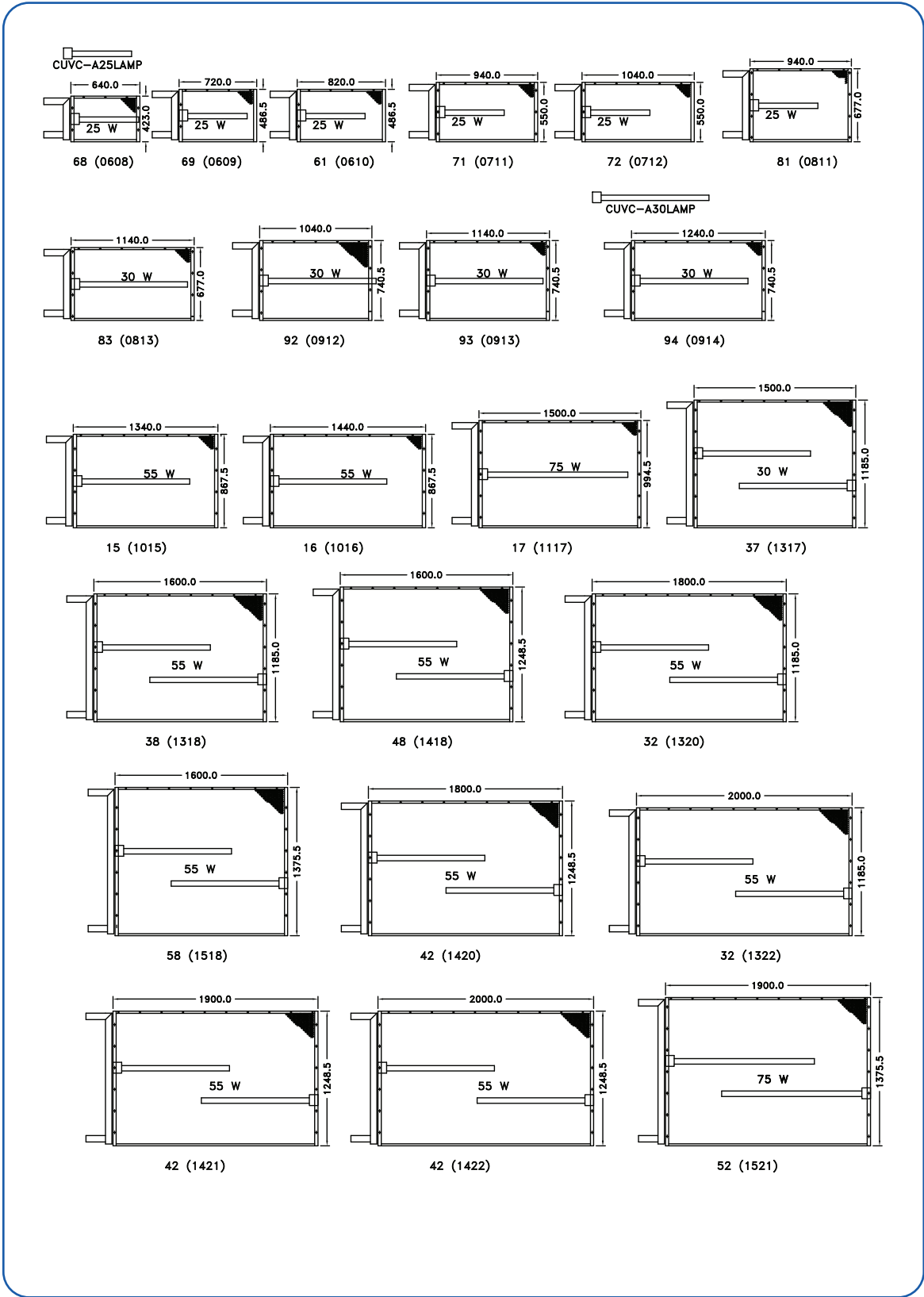

UV Lamp 39GNS Series

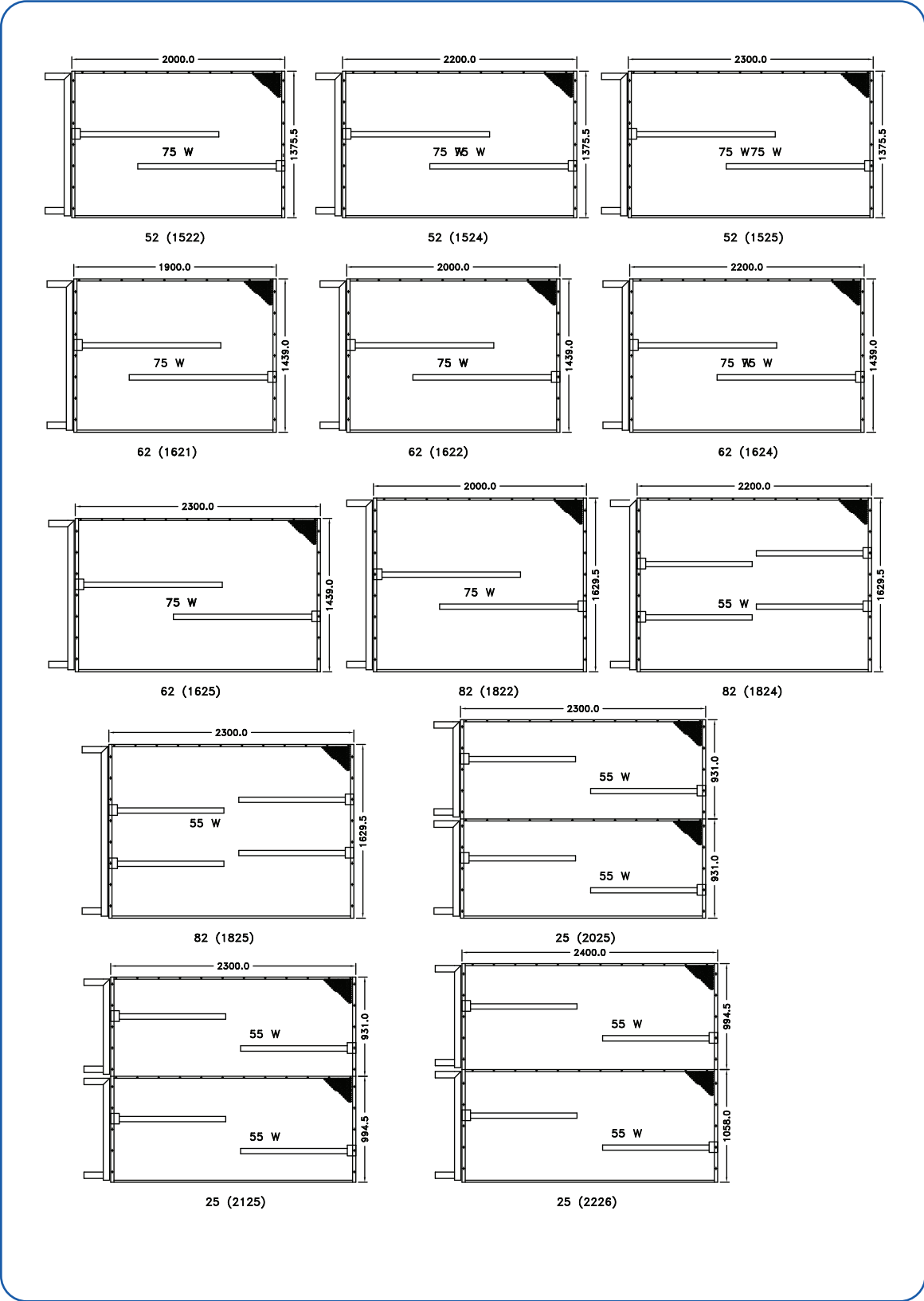

UV Lamp 39GNS Series

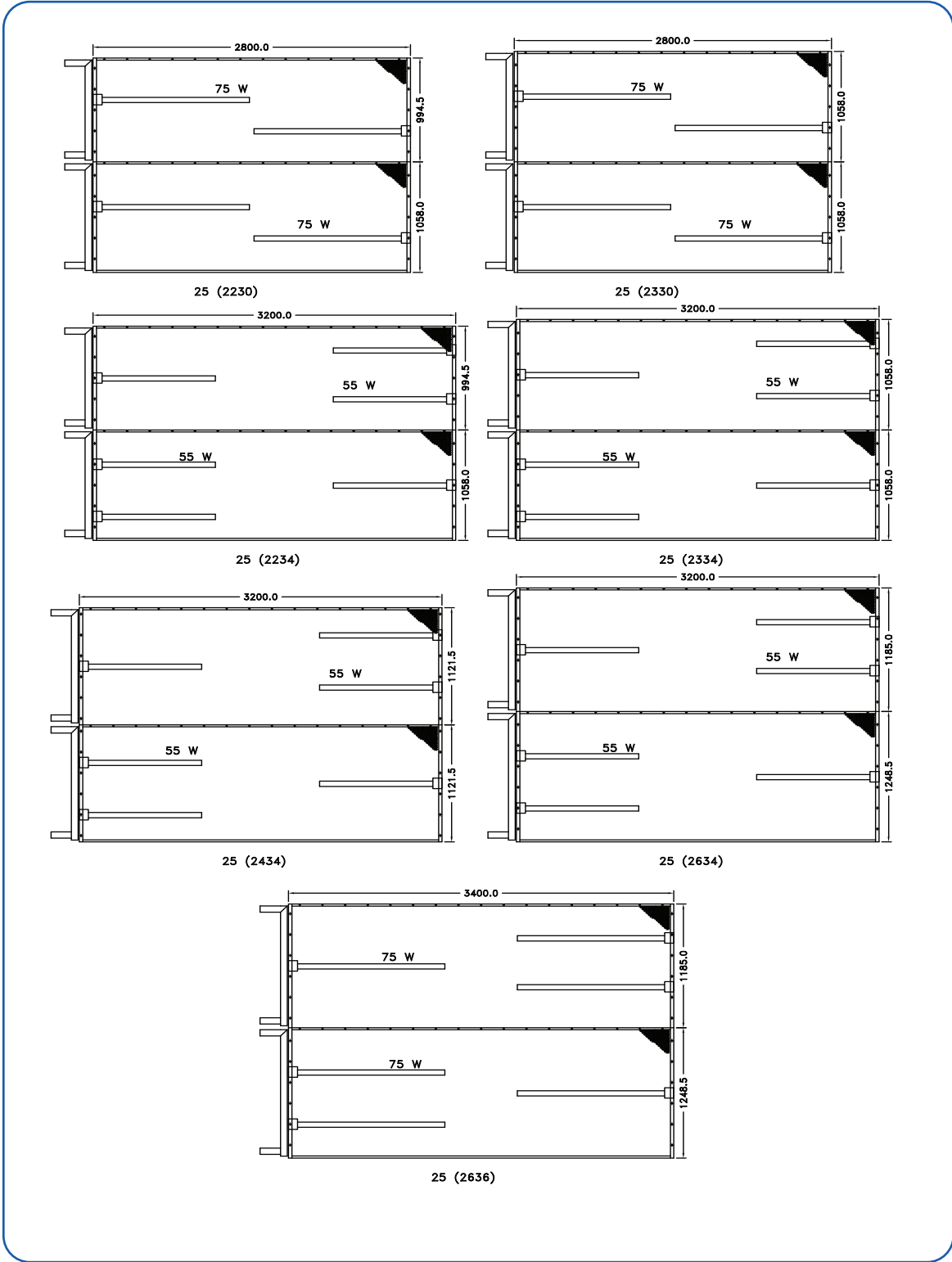

บริษัท แคนเรียร์ (ประเทศไทย) จำกัด
 1858/63-74 ชั้น 14, 15
 ถ.เทพรัตน กม. 4.5 แขวงบางนาใต้
 เขตบางนา กรุงเทพฯ 10260
 โทร. 0-2090-9999 แฟกซ์: 0-2751-4778

Carrier (Thailand) Ltd.
 1858/63-74 , 14th, 15th Floor,
 Debaratna Road, Km.4.5, Bangna Tai,
 Bangna Bangkok 10260 Thailand
 Tel. 0-2090-9999 Fax: 0-2751-4778



YOUR CARRIER MAN :

บริษัทฯ ขอสงวนสิทธิ์ที่จะเปลี่ยนแปลงรายละเอียดข้างต้น โดยมิต้องแจ้งให้ทราบล่วงหน้า
 Carrier reserves the right to make changes in specifications without prior notice.