



AIR CONDITIONER

User Manual

Chilled Water Fan Coil Unit

Model Name :

Chilled water coil Way round cassette type

40VRS018W

40VRS024W

40VRS036W

40VRS048W

40VRS060W

User Manual

Thank you for purchasing "Carrier" air conditioners.

Please read this installation manual carefully before installing the air conditioner.

This manual explains how to install only the fan coil unit.

After installation, please send this installation guide along with the air conditioner operation manual to the user. and instructs users to keep both manuals for future reference.

Generic Denomination : Air Conditioner

Definition of Qualified Installer or Qualified Service Person

The air conditioner must be installed, maintained, repaired and dismantled by a qualified installer or qualified service person. When any of these actions are required, please ask a qualified installer or qualified service person to perform the job.

Contents

	Page
1 Safety precautions	3
2 Parts name	5
3 Wireless remote	5
4 Wire remote	6
5 Maintenance	12
6 Troubleshooting	14
7 Error code	15

Definition of Protective Gear

When the air conditioner is to be transported, installed, maintained, repaired or removed, wear protective gloves and 'safety' work clothing.

In addition to such normal protective gear, wear the protective gear described below when undertaking the special work detailed in the following table.

Failure to wear the proper protective gear is dangerous because you will be more susceptible to injury, burns, electric shocks and other injuries.

Work undertaken	Protective gear worn
All types of work	Protective gloves 'Safety' working clothing
Electrical-related work	Gloves to provide protection for electricians Insulating shoes Clothing to provide protection from electric shock
Work done at heights (50 cm or more)	Helmets for use in industry
Transportation of heavy objects	Shoes with additional protective toe cap

1. Safety precautions

The manufacturer shall not assume any liability for the damage caused by not observing the description of this manual.

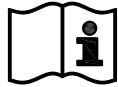

Read the precautions carefully before using this manual.



WARNING

General

- Before starting to install the air conditioner, read through the Installation Manual carefully, and follow its instructions to install the air conditioner.
- Only a qualified installer or service person is allowed to do installation work. Inappropriate installation may result in water leakage, electric shock or fire.
- Before opening the air supply hood of the fan coil unit or the electric control panel of the fan coil unit. Must be moved to the OFF position, otherwise a short circuit can occur to internal parts through the contacts. Only qualified installer or qualified service personnel is allowed to open the air inlet of the fan coil unit or the electrical control panel of the unit. and perform the required works.
- Before carrying out the installation, maintenance, repair or removal work, set the circuit breaker to the OFF position. Otherwise, electric shocks may result.
- Place a “Work in progress” sign near the circuit breaker while the installation, maintenance, repair or removal work is being carried out. There is a danger of electric shocks if the circuit breaker is set to ON by mistake.
- Only a qualified installer or qualified service person is allowed to undertake work at heights using a stand of 50 cm or more or to remove the intake grille of the fan coil unit to undertake work.
- Wear protective gloves and safety work clothing during installation, servicing and removal.
- Do not touch the aluminum fin of the unit. You may injure yourself if you do so. If the fin must be touched for some reason, first put on protective gloves and safety work clothing, and then proceed.
- When work is performed at heights, use a ladder which complies with the ISO 14122

standard, and follow the procedure in the ladder’s instructions. Also wear a helmet for use in industry as protective gear to undertake the work.

- Before cleaning the filter or other parts of the outdoor unit, set the circuit breaker to OFF without fail, and place a “Work in progress” sign near the circuit breaker before proceeding with the work.
- Before working at heights, put a sign in place so that no-one will approach the work location, before proceeding with the work. Parts and other objects may fall from above, possibly injuring a person below. While carrying out the work, wear a helmet for protection from falling objects.
- The air conditioner must be transported in stable condition. If any part of the product is broken, contact the dealer.
- When the air conditioner must be transported by hand, carry it by two or more people.
- Do not move or repair any unit by yourself. There is high voltage inside the unit. You may get electric shock when removing the cover and main unit.

Selection of installation location

- Do not install in a location where flammable gas leaks are possible. If the gas leak and accumulate around the unit, it may ignite and cause a fire.
- To transport the air conditioner, wear shoes with additional protective toe caps.
- To transport the air conditioner, do not take hold of the bands around the packing carton. You may injure yourself if the bands should break.
- Install the indoor unit at least 2.5 m above the floor level since otherwise the users may injure themselves or receive electric shocks if they poke their fingers or other objects into the indoor unit while the air conditioner is running.
- Do not place any combustion appliance in a place where it is directly exposed to the wind of air conditioner, otherwise it may cause imperfect combustion.

Installation

- When the fan coil unit is to be suspended, the designated hanging bolts (M10 or W3/8) and nuts (M10 or W3/8) must be used.
- Install the air conditioner securely in a location where the base can sustain the weight adequately. If the strength is not enough, the unit may fall down resulting in injury.

- Follow the instructions in the Installation Manual to install the air conditioner. Failure to follow these instructions may cause the product to fall down or topple over or give rise to noise, vibration, water leakage or other trouble.
- Carry out the specified installation work to guard against the possibility of high winds and earthquake. If the air conditioner is not installed appropriately, a unit may topple over or fall down, causing an accident.
- Use forklift to carry in the fan coil units and use winch or hoist at installation of them.

Electrical wiring

- Only a qualified installer or qualified service person is allowed to carry out the electrical work of the air conditioner. Under no circumstances must this work be done by an unqualified individual since failure to carry out the work properly may result in electric shocks and/or electrical leaks.
- To connect the electrical wires, repair the electrical parts or undertake other electrical jobs, wear gloves to provide protection for electricians and from heat, insulating shoes and clothing to provide protection from electric shocks. Failure to wear this protective gear may result in electric shocks.
- Use wiring that meets the specifications in the Installation Manual and the stipulations in the local regulations and laws. Use of wiring which does not meet the specifications may give rise to electric shocks, electrical leakage, smoking and/or a fire.
- Connect earth wire. (Grounding work) Imperfect grounding can cause electric shock.
- Do not connect earth wires to gas pipes, water pipes, and lightning conductor or telephone earth wires.
- After completing the repair or relocation work, check that the earth wires are connected properly.
- Install a circuit breaker that meets the specifications in the installation manual and the stipulations in the local regulations and laws.
- Install the circuit breaker where it can be easily accessed by the agent.
- To install the circuit breaker outdoors, install one which is designed to be used outdoors.
- Under no circumstances the power wire must not be extended. Connection trouble in the places where the wire is extended may give rise to smoking and/or a fire.
- Electrical wiring work shall be conducted according to law and regulation in the

community and installation manual. Failure to do so may result in electrocution or short circuit.

Test run

- Before operating the air conditioner after having completed the work, check that the electrical control box cover of the fan coil unit are closed, and set the circuit breaker to the ON position. You may receive an electric shock if the power is turned on without first conducting these checks.
- If there is any kind of trouble (such as an error display has appeared, smell of burning, abnormal sounds, the air conditioner fails to cool or heat or water is leaking) has occurred in the air conditioner, do not touch the air conditioner yourself but set the circuit breaker to the OFF position, and contact a qualified service person. Take steps to ensure that the power will not be turned on (by marking "out of service" near the circuit breaker, for instance) until qualified service person arrives. Continuing to use the air conditioner in the trouble status may cause mechanical problems to escalate or result in electric shocks or other trouble.

Explanations given to user

- Upon completion of the installation work, tell the user where the circuit breaker is located. If the user does not know where the circuit breaker is, he or she will not be able to turn it off in the event that trouble has occurred in the air conditioner.
- After the installation work, follow the User Manual to explain to the customer how to use and maintain the unit.

Relocation

Only a qualified installer or qualified service person is allowed to relocate the air conditioner. It is dangerous for the air conditioner to be relocated by an unqualified individual since a fire, electric shocks, injury, water leakage, noise and/or vibration may result.

2. Parts name

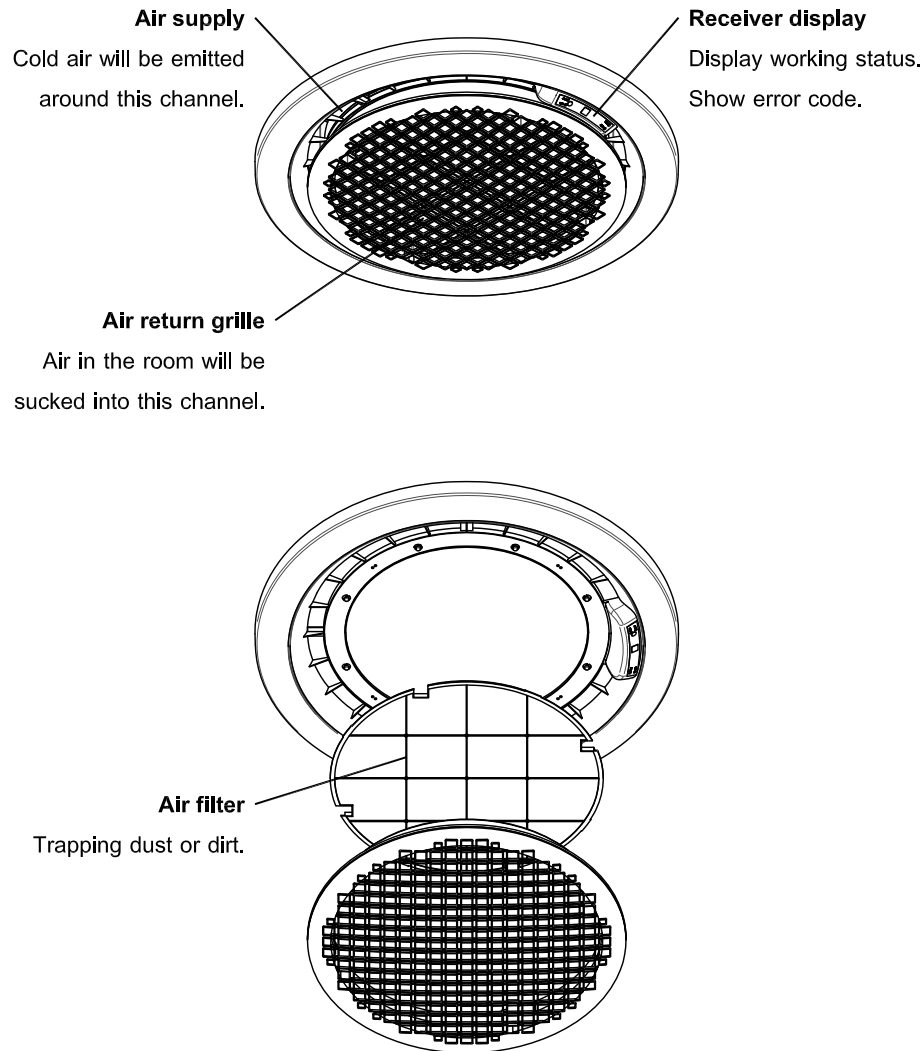

3. Wireless remote

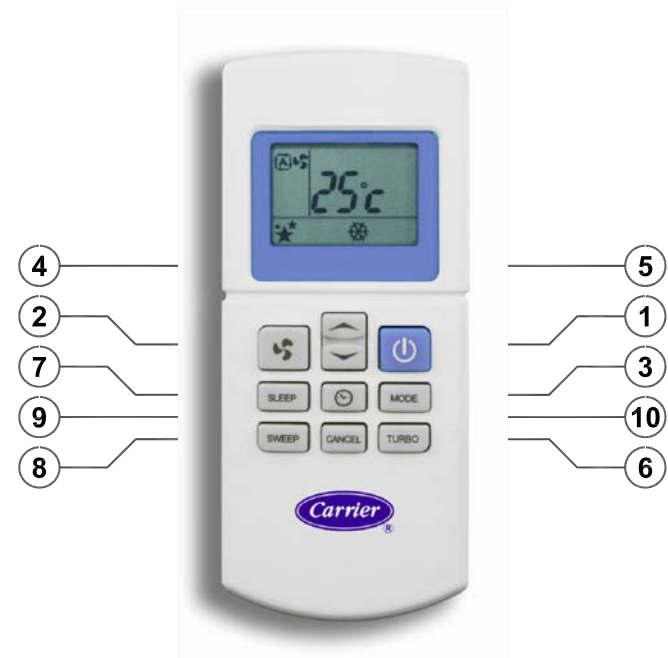

The wireless remote has 10 buttons by follows:

- ① POWER: Press to turn on/off the air conditioner.
- ② FAN: Press to adjust fan speed.
AUTO->HIGHT->MEDIUM->LOW
- ③ MODE: Press to select operation mode. FAN->COOL->DRY.
- ④ UP: Press to increase set point temperature or TIMER.
- ⑤ DOWN: Press to decrease set point temperature or TIMER.
- ⑥ TURBO: Press to operate turbo function, press again to cancel.
- ⑦ SLEEP: Press to operate sleep function, press again to cancel.
- ⑧ SWEEP: Press to operate sweep function, press again to cancel.
- ⑨ CLOCK/TIMER: Press to set time function and turn on/off TIMER.
- ⑩ CANCEL: Press to cancel TIMER.

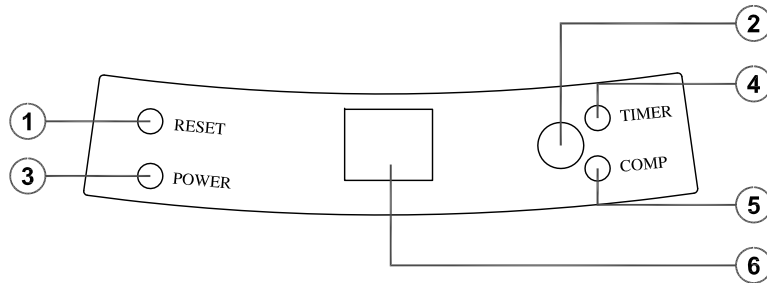

Remote control receiving panel on the front panel.

- ① Temporary operation button
Operate the air conditioner without the remote control can be process with a temporary operation button on the receiver in the following cases.
 - The battery in the remote controller expired.
 - A trouble occurred on the remote controller.
 - The remote controller has been lost.
 The air conditioner will operate in COOL MODE, temperature at 24°C.
- ② Signal receiver
Receives the signal sent from the remote control.
- ③ Alarm light 'POWER' (Green light)
This light comes on when the air conditioner is turned on.
- ④ Alarm light 'TIMER' (Green light)
This light comes on when the air conditioner on/off time is set.
- ⑤ Alarm light 'COMPRESSOR' (Orange light)
This light is on when the compressor is working.
- ⑥ LED 7-SEGMENT: display indicator
Show temperature and various errors when there is a problem.

How to use the remote control

- When the air conditioner receives the correct signal from the remote control. There will be a "beep" sound.
- When signal from the remote control is blocked by an obstacle. There will be no response from the command.
- Choose to press just one button. If the keys are pressed more than one key at the same time, operation may be faulty.

① POWER

When pressing the  button (while in off state) it will turn on the air conditioner as default and the room temperature light will be on when the unit is in off state. Display does not shown anything except the indicator light for setting the time for the air conditioner to (START) or the time for the air conditioner to (STOP).

② FAN

Pressing  to control the operation of the fan. When pressing this button, the fan will change the speed in the following order:

- HIGH, MEDIUM, LOW The fans will blow at constant speed High, Medium, Low respectively.
- AUTO Set the fan to be in automatic mode. When the room is hot, the fan will blow at high speed to cool the air. As the room begins to cool down, the fan automatically adjusts its speed down to medium and finally low.

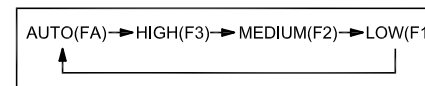

AUTO FAN

- If the difference temperature is 3°C or more,
The fan will run at high speed.
- If the difference temperature is 2°C,
The fan will run at medium speed.
- If the difference temperature is 1°C or less,
The fan will run at low speed.

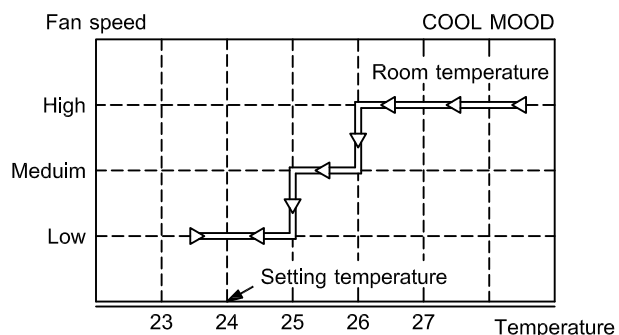

③ MODE MODE

- Pressing **MODE** Can set the air conditioner to work in 3 systems: FAN, COOL, DRY
- FAN MODE: When in this system, the unit will only operate as a FAN. The display of the remote will show the FAN status while the buttons **SLEEP** and **UP** / **DOWN** not work.
 - COOL MODE: The display of the remote will show COOL status. The unit will work as a cooling air conditioner, by:
 - The compressor will start when the room temperature > set temperature +1°C.
 - The compressor will stop working when the room temperature < the set temperature value. However, it must be under the condition that the compressor can be resumed working after stopping for 3 minutes.
 - DRY MODE: The screen of the remote control will show DRY status. Used when dehumidifying the room.

④ UP / DOWN TEMPERATURE SETTING

Press **UP** / **DOWN** (This button only works when in DRY or COOL operation mode) to increase or decrease the desired temperature. The screen of the remote will show the setting temperature value, which can be set in the range of 18-30 °C

⑥ TURBO TURBO

- Press **TURBO** While in FAN or COOL MODE, the fan will runs at maximum speed.
- Cancellation can be done by pressing the button **TURBO** again or press the **STOP** button.
 - When TURBO is cancelled, the fan will resume running at the previously set speed.

⑦ SLEEP SLEEP

Press **SLEEP** (This button only works when in COOL operation mode), where the screen of the remote control will show the symbol. The air conditioner will automatically adjusts the temperature while we sleep.

- When the air conditioner is in the cooling system. The set temperature value will increase by 1°C after 1 hour and return to normal operation.

Note:

- Cancellation can be done by pressing the **SLEEP** button again.
- While in the SLEEP condition and the temperature adjustment button is pressed. The temperature value will be increased / decreased by 1°C from the last set temperature value.
- While SLEEP MODE is active, if the MODE change button is pressed, will cause SLEEP to stop working.
- When outage, or the air conditioner is turned off or change the mode. It will cancel SLEEP condition.

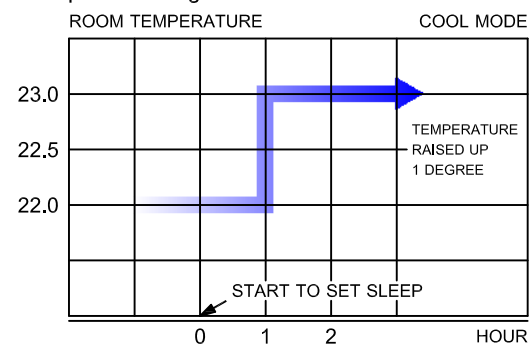

The operation diagram of SLEEP



⑧ SWEEP SWEEP (not available in this model)





⑨ CLOCK / TIMER

- Press **CLOCK** to set the clock on the remote or for advance air conditioning on-off timer. Setting the clock on the remote unit is done by;
- Press **CLOCK** Symbol on remote screen will flashing.

- Press  /  to set the time. Press and hold the button to make the numbers increase or decrease quickly, the numbers showing the time will flashing.
- Press any other button that emits a signal. The timer indicator will stop flashing to end the timer setting.
- Setting the clock has no effect to the operation of the system except for setting the ON/OFF timer.



Setting an advance time for on/off the air conditioning

Can set the on/off time 24 hours in advance.

- Press  Twice until the symbol ON on the remote flashes to set the time to turn on the air conditioner or press  Three Times until the symbol OFF on the remote flashes to set the time to off on the air conditioner
- Press  /  to set the time, by press and hold the button to make the numbers increase or decrease quickly.
- Press  again, or press other button that emits a signal. The numbers showing the time will stop flashing. This will ends the on/off timer setting.

10  **CANCEL**

Press  to cancel advance on/off air conditioning.

- Press  until the symbol ON or OFF that want to cancel is flashing.
- Press  the symbol ON or OFF or both symbol will disappear.

Error code when there is a problem.

LED 7-SEGMENT: The display on the front panel will show various errors that occur in 7- segment as shown in the table.

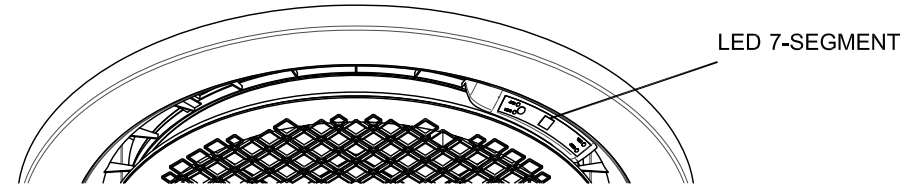

CODE	CAUSE	CORRECTION
EA	<ul style="list-style-type: none"> -Drain motor pump malfunction/broken -Drain pipe goes down / slope rate is not enough / Raise the upstream drain pipe higher than standard required / blocked. -The drain pan is dirty / clogged. -Float switch stuck (dirty)/ broken. -The control panel is malfunctioning / broken. -Incorrect wiring. 	<ul style="list-style-type: none"> -Check drain motor pump. -Check drain level/clogging and clean. -Check the drain pan. and clean. -Check float switch / measure Ohm. -Check the control panel. -Check all wiring connections.
EE	<ul style="list-style-type: none"> Room temperature sensor broken or shorted. 	<ul style="list-style-type: none"> Check the condition of the room temperature sensor / Measure the resistance (6.8 kilo-Ohm) If broken, proceed to change.

4. Wire remote



The wire remote has 10 buttons by follows:

- ① POWER: Press to turn on/off the air conditioner.
- ② MODE: Press to select operation mode. FAN->COOL->DRY.
- ③ FAN: Press to adjust fan speed (AUTO->HIGHT->MEDIUM->LOW MODE).
- ④ UP: Press to increase set point temperature or TIMER.
- ⑤ DOWN: Press to decrease set point temperature or TIMER.
- ⑥ TIMER: Press to set time function and turn on/off TIMER.
- ⑦ ECONO: Press to operate econo function, press again to cancel.
- ⑧ TURBO: Press to operate turbo function, press again to cancel.
- ⑨ SLEEP: Press to operate sleep function, press again to cancel.

- ⑩ SWEEP: Press to operate sweep function, press again to cancel. (N/A function)

Indicator light: there are 6 LEDs divided into:

- Ⓐ FAN LED: show status of FAN operation.
- Ⓑ COOL LED: show status of COOL MODE or DRY MODE.
- Ⓒ TIMER LED: show status of TIMER operation.
- Ⓓ ECONO LED: show status of ECONO MODE.
- Ⓔ TURBO LED: show status of TURBO operation.
- Ⓕ SLEEP LED: Show the status of setting automatic temperature while sleeping.



LED 7-SEGMENT: show room temperature and show SETTING TEMPERATURE / FAN SPEED/TIMER when user set. (Decimal point show status of compressor operation)

① **POWER**

Press **POWER** button (when power off) then air conditioner will run according to the last program which is set on the remote and display the room temperature in °C. When the unit is off the display shows nothing except TIMER (if it is set).

② **MODE**

Press **MODE** to select operation mode (FAN and COOL MODE)

- FAN MODE: The unit will operate fan only and the display show fan status.
- COOL MODE: The unit will operate in cool mode as follows:
 - Compressor will start when room temperature higher than set point > 1°C
 - Compressor will stop when room temperature ≤ set point and need 3 minutes delay for starting run again.

③ **FAN**

Press **FAN** button (only in FAN MODE and COOL MODE) to adjust fan speed in the following sequence:

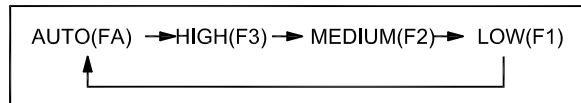

When the unit operate in FAN MODE and COOL MODE, the FAN AUTO will operates as follows:

- If the difference is 3°C or more, the fan will operate at high speed.

- If the difference is 2°C, the fan will operate at medium speed.
- If the difference is 1°C or less, the fan will operate at at low speed.

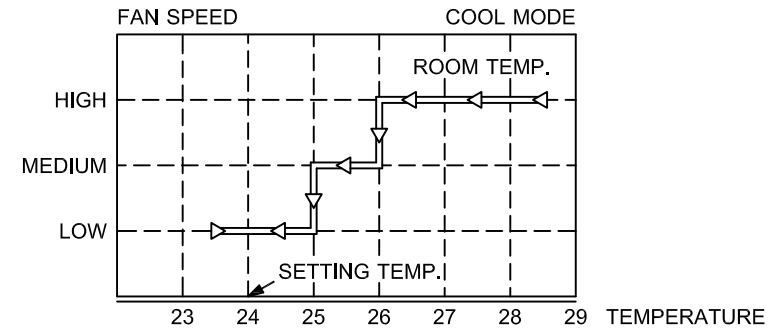

④ **TEMPERATURE SETTING**

Press **TEMPERATURE SETTING** to adjust room temperature(Setting range 18-30°C)

⑥ **TIMER**

Press **TIMER** button to set the time turn on/off power.

How to set TIMER

- Press **TIMER** button when the TIMER led is off to set TIIMER (press this button when power off to set time to turn on and vice versa).
- Press **TEMPERATURE SETTING** to set the time.
- Wait about 5 seconds then display will show main menu.

How to cancel TIMER

- Press **TIMER** button again to cancel.

⑦ **ECONO**

Press **ECONO** button when the unit operate in COOL MODE to set

ECONO function then ECONO led on the display will be displayed and the system will operate in the energy saving mode (The unit will operate at 25°C and AUTO FAN). Press **ECONO** button again to cancel.

8 **TURBO TURBO**

Press **TURBO** button when the unit operate in FAN MODE or COOL MODE to turn on TURBO function then TURBO led will be displayed and the fan will operate at a special speed (TURBO SPEED). Press **TURBO** button again to cancel TURBO function or press **↻** button to adjust fan speed.

9 **SLEEP SLEEP**

Press **SLEEP** button (in COOL MODE only) to turn on SLEEP function. The system will control temperature while we are sleeping. In COOL MODE the temperature will increase 1°C after we have slept for 1 hour then unit is back to normal operation and the SLEEP symbol disappeared.

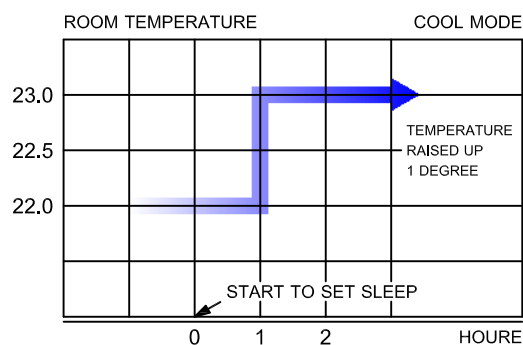





- Press **SLEEP** button again to cancel.
- In SLEEP FUNCTION if you adjust temperature, SLEEP will operate according the last temperature.
- In SLEEP FUNCTION if you change another mode, SLEEP will be canceled.
- In SLEEP FUNCTION if the unit stops working (short circuit or on/off power) SLEEP will be canceled.

Error code when there is a problem.

LED 7-SEGMENT: The display on the front panel & wire remote control will show various errors that occur in 7- segment as shown in the table.

CODE	CAUSE	CORRECTION
E A	<ul style="list-style-type: none"> -Drain motor pump malfunction/broken -Drain pipe goes down / slope rate is not enough / Raise the upstream drain pipe higher than standard required / blocked. -The drain pan is dirty / clogged. -Float switch stuck (dirty)/ broken. -The control panel is malfunctioning / broken. -Incorrect wiring. 	<ul style="list-style-type: none"> -Check drain motor pump. -Check drain level/clogging and clean. -Check the drain pan, and clean. -Check float switch / measure Ohm. -Check the control panel. -Check all wiring connections.
E 8	Room temperature sensor broken or shorted.	Check the condition of the room temperature sensor / Measure the resistance (6.8 kilo-Ohm) If broken, proceed to change.

More detail

- In the control system when there is an error due to the computer system which may be caused by unstable voltage or interference, the system will prompt the computer to restart (RESET) immediately.
- In case of power failure when the power returns to normal operation, the system will run according to the last program which is set including swing value and without remembering SLEEP and TIMER values. If any value has changed it must be stored in memory for at least 5 seconds before the power failure occurs when the power returns the system will run according to the values in memory.
- In the case of compressor stops working there must always be 3 minutes delay before resuming again and in case of disconnecting the power supply system and then re-supplying the power there must be 3-4 minutes delay in compressor operation at random.
- In the case of compressor starts to work it must work for at least 24 seconds before it can stop even change mode or turn off power.
- The brightness of LED and 7-SEGMENT can be adjusted by pressing and holding button SLEEP and  for 5 seconds. Press again to back normal. The adjustments are memorized in the air conditioner.
- WIFI ENABLE/DISABLE: Press and hold button  and  to set WIFI enable or disable.
- The minimum temperature that can be set to 21 °C by pressing and holding button  and  for 5 seconds. Press again for cancel.

5. MAINTENANCE

Before performing maintenance, please make sure the circuit breaker is turned off.

Removing the air inlet grille and air filter

- Hold the edge of the air inlet grille.
- Turn into a counterclockwise direction. The air inlet grille will come off the front cover.
- Remove the air filter from the air inlet grille.

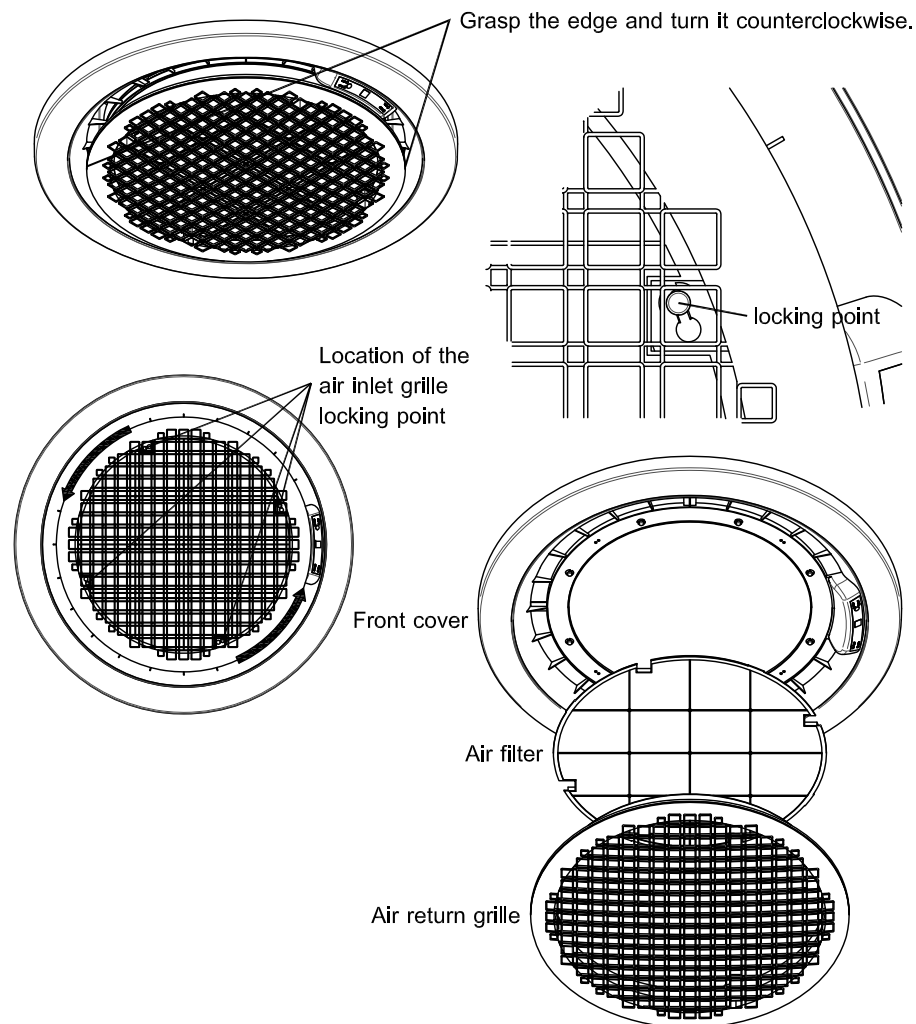

Cleaning the air filter

Failure to clean the air filter, In addition to reducing the cooling efficiency of the air conditioner, It also has the effect of causing air conditioning failures such as dripping water.

- Turn off the air conditioner.
- Remove the air filter.
- Use a vacuum cleaner to remove dirt from the air filter.
- Wipe the air filter with a sponge or towel moistened with dishwashing detergent.

(Do not use a metal brush to clean.)

- Rinse off the dishwashing liquid with plain water.
- After cleaning the air filter with water Let the air filter dry in the shade.
- Put the air filter back into the air conditioner.

Caution

Do not turn on the air conditioner when the panel and air filter removed.

Cleaning the evaporator coil

- Clean the evaporator coil by using a sponge dipped in liquid soap to cover the coil and then gently brush with a soft metal wire brush until clean, at least every 3 months (preferably by a qualified service person).

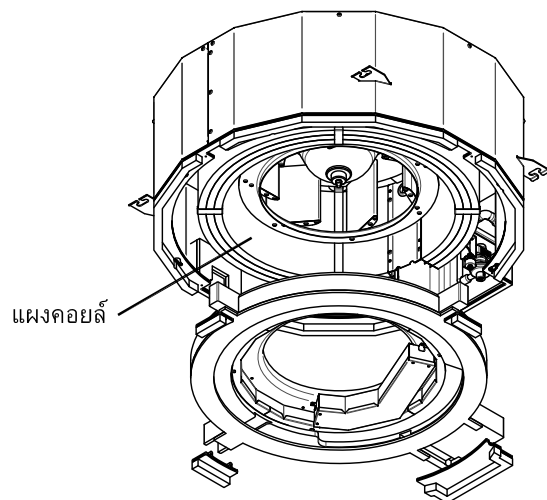

Notice

Annual Maintenance

- To prevent loss from the environment It is recommended that you clean and maintain the air conditioner regularly. When using the air conditioner for a long time It is recommended to perform maintenance on the machine at intervals (once a year).
- According to general practice When using the air conditioner for 8 hours or more per day. The air conditioner must be cleaned at least every 3 months by an expert technician.
- Regular maintenance as mentioned above will extend the service life of the product. It also reduces the cost of air conditioning users as well. Without maintaining the air conditioner may cause the performance of the air conditioner to decrease and cause water leakage.
- This product has a drain pump. If used in a place full of dust or oil mist, the pump will become clogged and will not be able to drain properly. The drain pump should be cleaned periodically. For how to clean the drain pump, please contact your dealer.

Pre-Maintenance Inspection

The following checks should be carried out by an experienced technician.

PART	VERIFICATION
Heat exchanger	Access from the inspection hatch and remove the access panel. Check for blockage or damage to the heat exchanger.
Fan Motor	Access from the inspection channel and check if there are any abnormal sounds.
Fan	Access from the inspection hatch and remove the access panel. Check to see if the fan is wobbly, damaged or dusty.
Air filter	For the installation location and check if there are any stains or cracks on the air filter.
Drain tray	Access from the inspection hatch and remove the access panel. Check if there is blockage or waste water.

Maintenance List

Part	Checking (Review / Hearing)	Maintenance
heat exchanger	Dust/dirt clogged, scratches	Clean the heat exchanger
Fan Motor	Sound	Investigate by proper means when abnormal noise occurs.
Air filter	dust / dirt, fracture	Use water to clean the filter when there is dirt. Replace when damaged
Fan	Rising, balance, dust/dirt, shape	Replace the fan when it vibrates during operation or is unbalanced. Scrub or clean the fan when it gets dirty.
Air inlet / outlet grille	Dust/dirt, scratches	Repair or replace when parts are deformed or damaged.
Drain tray	clogging of dust/dirt, effluent contamination.	Clean the drain tray. and check the laying of pipes to be in a horizontal plane for good drainage.

6. Troubleshooting

When the fan coil unit is malfunctioning. Before calling for service personnel, please check make sure that:

1. The circuit breaker is in the ON position.
2. The temperature control switch is in the lowest number.
3. The fan control switch is in the HIGH position.
4. The air filter panel is in sufficiently clean condition.
5. The power switch is in the COOL mode.

When checking, if it is found that the air conditioner is still not working or unable to cool normally Turn off the power switch and main switch, and call a trusted service technician for service.

Consideration before calling a technician.

Check the following items before calling a technician because you may be able to fix it. But if after checking, the air conditioner still malfunctions. Please stop using the air conditioner and consult your dealer.

Malfunction	Preliminary Checking
Air conditioner not working	>Check wires that missing or not. >Check the electric current crash or not. >Check remote control that set up time correct or not.
Cooling capacity drop	>Check temperature set up suitable or not. >Check that the sunlight in the room directly or not. >Check the door and windows it open or not. > Check if anything is blocking the air vents inside of the unit. > Check if there is an excessive heat source in the room. > Check if the ventilators are working or not. > Check if the air filter is dirty or not.
Steam or smoke comes out from the air conditioner while it is operating.	> The cause may be caused by the heat in the room reacting with the cold that comes out of the air conditioner.

7. Error code

LED 7-SEGMENT: The display on the front panel and on the wired remote control will show various errors that occur in 7- segment as shown in the table.

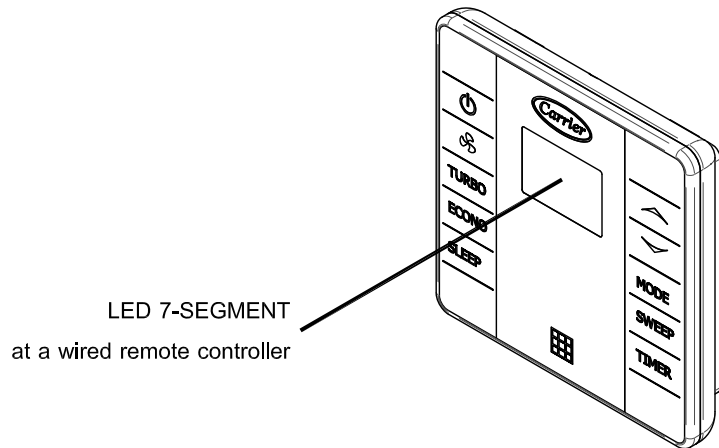
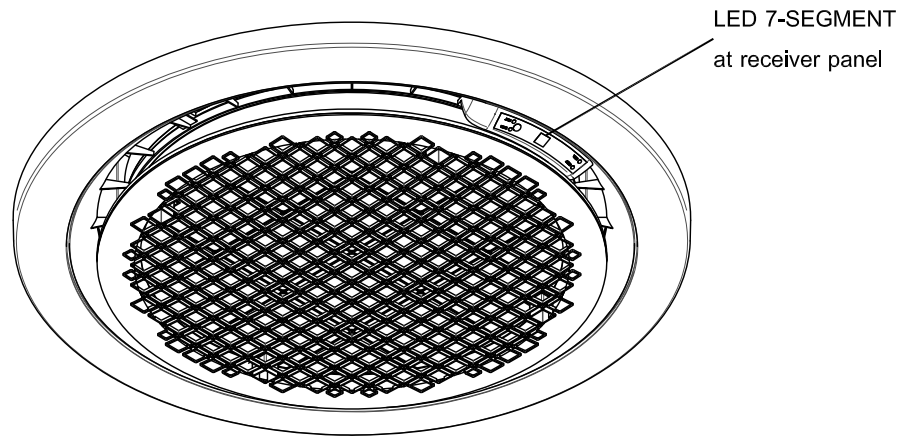

CODE	CAUSE	CORRECTION
EA	<ul style="list-style-type: none"> -Drain motor pump malfunction/broken -Drain pipe goes down / slope rate is not enough / Raise the upstream drain pipe higher than standard required / blocked. -The drain pan is dirty / clogged. -Float switch stuck (dirty)/ broken. -The control panel is malfunctioning / broken. -Incorrect wiring. 	<ul style="list-style-type: none"> -Check drain motor pump. -Check drain level/clogging and clean. -Check the drain pan. and clean. -Check float switch / measure Ohm. -Check the control panel. -Check all wiring connections.
EB	<ul style="list-style-type: none"> Room temperature sensor broken or shorted. 	<ul style="list-style-type: none"> Check the condition of the room temperature sensor / Measure the resistance (6.8 kilo-Ohm) If broken, proceed to change.



Carrier (Thailand) Co., Ltd

1858/63-74 Fl. 14-15
Debaratana KM. 4.5 Str., South Bangna Ward,
Bangna Dist., Bangkok 10260

Carrier Call Center

Tel : 662-090-9900

