



AQUAEDGE greenspeed  TM

19PV Magnetic Bearing Oil-free Centrifugal Liquid Chiller

Cooling capacity: 100~350RT





In 1998, Time magazine named Dr. Carrier one of its 20 most influential builders and titans of the 20th century.

Carrier is a leading global provider of innovative HVAC, refrigeration, fire, security and building automation technologies. Supported by the iconic Carrier name, the company's portfolio includes industry-leading brands such as Carrier, Kidde, Edwards, LenelS2 and Automated Logic. Carrier's businesses enable modern life, delivering efficiency, safety, security, comfort, productivity and sustainability across a wide

range of residential, commercial and industrial applications.



Nomenclature

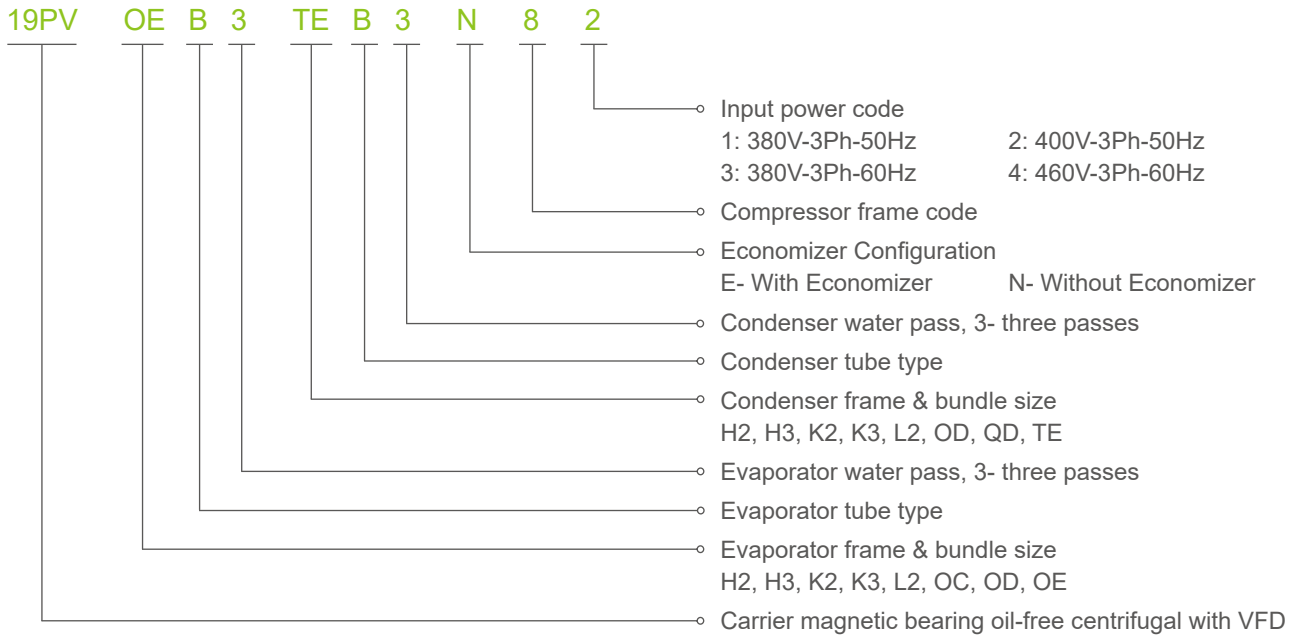

Operating Range

Cooling		
Evaporator	Minimum	Maximum
Entering temperature at start-up	-	32°C
Leaving temperature during operation	3.3°C *	20°C
Entering/leaving temperature difference at full load	2.8°C	11.1°C
Condenser	Minimum	Maximum
Entering temperature at start-up	8°C	-
Leaving temperature during operation	15°C	45°C
Entering/leaving temperature difference at full load	2.8°C	11.1°C

- Notes:
- * If the leaving water temperature is below 3.3°C , a frost protection solution must be used.
 - Within 3 minutes after the start up of the unit, the unit should function inside the operational envelop, a bypass valve should be installed between the condenser water inlet and outlet pipe, if condenser outlet temperature is between 8°C and 15°C .
 - During storage and transport of the unit the minimum and maximum permissible temperatures are -20°C and 60°C . These temperatures should be taken into consideration for transport by container.

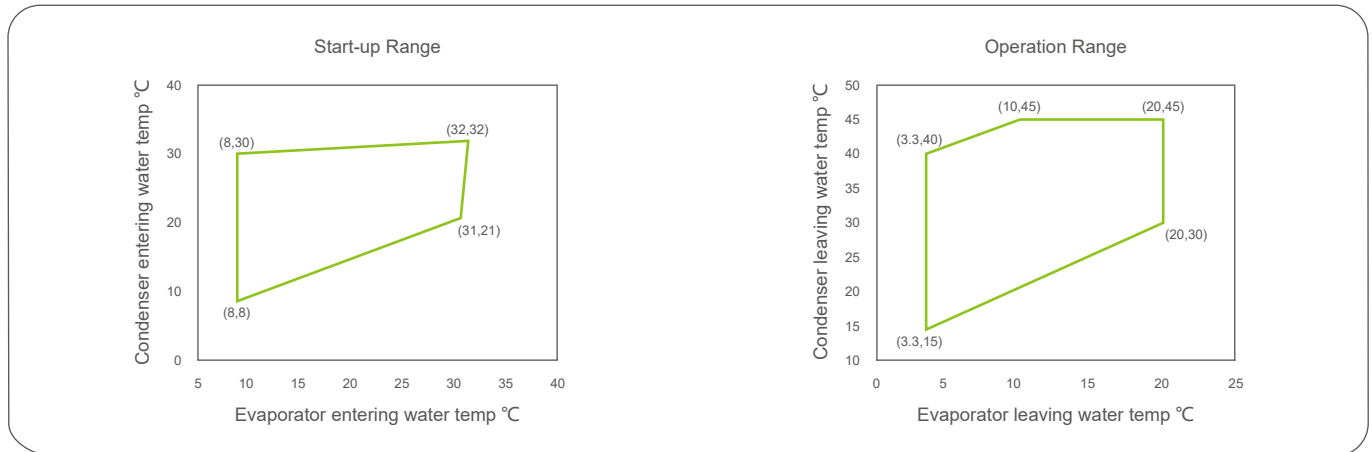

All data over 200Tons (50Hz) and all data (60Hz) in this catalogue is certificated in accordance with AHRI Standard 550/590 and 551/591 as represented in the selection software (E-Cat). Certified units may be found in the AHRI Directory at www.ahridirectory.org

<http://www.ahridirectory.org>

General features

- ✦ The latest generation AquaEdge 19PV magnetic bearing variable speed oil free centrifugal chillers are the perfect solution for commercial and industrial applications in the Office, Hotel, Healthcare, Shopping mall, Collective housing, Industry, Data center and Metro line station where installers, consultants and building owners require maximum quality and optimal performances, especially at part load. They are designed to meet current and future requirements in terms of energy efficiency, operation cost, versatility and compactness.
- ✦ The 19PV uses the most reliable technologies available today which guarantees compliance with the demanding requirements for high energy efficiency and CO₂ reduction to comply with the various applicable Asian directives and regulations.
 - Exclusive magnetic bearing two stages compressors
 - Low-noise and less vibration through magnetic levitation
 - Oil-free
 - Extremely efficient mechanically cleanable flooded evaporators
 - Environment stewardship refrigerant HFC-134a
 - Electrical power and remote control cabinet
 - 380/400V-3Ph-50Hz and 380/460V-3Ph-60Hz general power supply ($\pm 10\%$)
 - Advanced Carrier SmartView[®] control system
 - EMC/EMI filter meets IEC61800 C3 standard
 - Circuit breaker interlock with high pressure switch
- ✦ The 19PV is for air conditioning cooling application, as standard the unit can provide an evaporator leaving water temperature down to 3.3°C.



Stability

- Equipped with magnetic bearings radially and axially, the cutting-edge 19PV compressor can levitate the shaft, avoiding metal-to-metal contact thus eliminating the mechanical frictions and abrasions.
- The 19PV compressor with unparalleled robustness eliminates the oil related failures that would happen to conventional oil-lubricated compressor, calling for maintenance workload and cost.
- The built-in capacitor in compressor reserves electric energy and provides continuous power supply to retain the shaft levitated. The motor will become akin to a generator and slows down the shaft till it stops when unexpected power failure occurs.
- The Greenspeed intelligence ensures a negligible start-up current (<2amps) to minimize the shock to power grid.
- The electronic paddle-free flow switch can self-adapt smartly to the actual cooler size and fluid type.
- The distinct feedforward EXV control logic designed for high speed centrifugal compressor enables precise response to the changing load demand.
- The auto-adaptive control and sophisticated electronics guarantees moment-to-moment match with precision between chiller capacity and building load that varies over time.
- 19PV chillers can handle sudden and large load variations up to 30% change in water flow rate per minute while maintaining leaving chilled water temperature with in close tolerance of $\pm 1^\circ\text{C}$.
- In case of power outages, the 19PV can intelligently restart the compressor in a short period of time once the power recovers, and its cooling capacity can be rapidly recovered to the demanded cooling load.

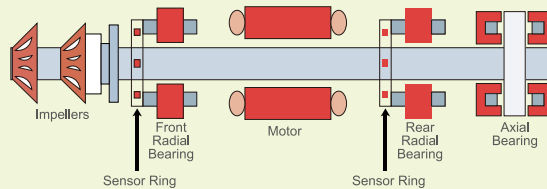
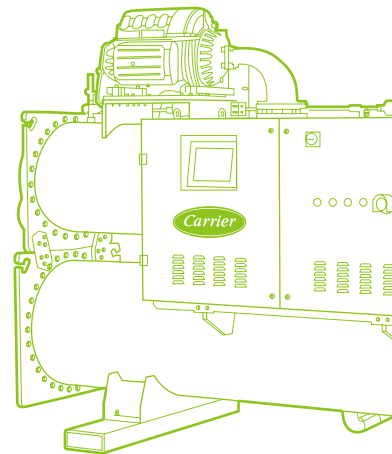

Quietness

- ✦ With its excellent acoustic performance down to 73dBA at a distance of 1.0 meter, 19PV is an ideal choice for sound sensitive environment. The factory-mounted acoustic treatments of 19PV compressor help to save the expenditure on sound treatments necessary for noisy conventional compressor.
 - The cast aluminum casing and high strength thermoplastic electronic enclosure effectively insulate the compressor which reduces the noise generated within.
 - The compressor's rotating parts are completely levitated by electromagnets which results in reduced friction and vibration, and hence lower operational sound.
 - Greenspeed[™] variable speed control adaptively turns down impeller speed at part load for better acoustic performance.
 - 19PV chillers meet 18001 standard recommended by Occupational Health and Safety Advisory Services (OHSAS).

High efficiency

- The 19PV is specifically designed for high performance both at full load and at part load, exceptional IPLV values set new benchmark for low energy consumption utilizing magnetic bearings, two stage centrifugal compression, variable speed permanent magnet motor and intelligent electronic controls.
 - High speed direct-driven motor and shaft reduces the mechanical loss by 75% by eliminating the gear system
 - The permanent-magnet synchronous motor powered by pulse-width modulation outperforms conventional motors with respect to efficiency, and therefore leads to distinguished chiller efficiency at full load and part load.
 - The adoption of oil-free system boosts the operational efficiency by eliminating the inevitable oil contamination in the refrigerant and heat exchanger.
 - Flooded multi-pipe evaporator and condenser for increased heat exchange efficiency.
 - High performance copper tube bundle with internal and external grooves along with enhanced fins improves chiller efficiency by reducing the heat transfer resistance.
 - The single refrigerant circuit design optimizes the heat exchange process, particularly at part load.
 - Electronic expansion device permits operation at a lower condensing pressure and improves utilization of the evaporator heat exchange surface.

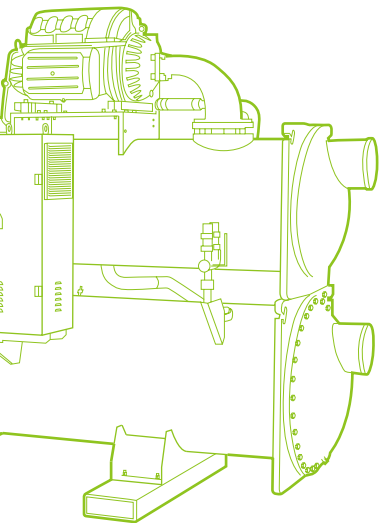
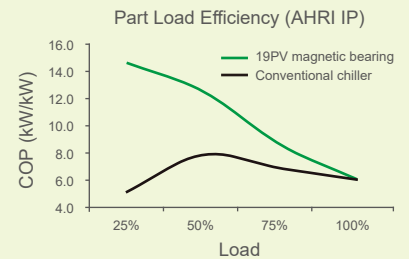

Lower operational cost

- 19PV chillers deliver high efficiency of up to 6.3 COP and 11.2 IPLV under AHRI rating conditions.
 - The operational cost decreases by 30-50% there by significantly reducing the Carbon foot print.
 - Oil related maintenance, costs and down time are completely eliminated since compressors are oil free.

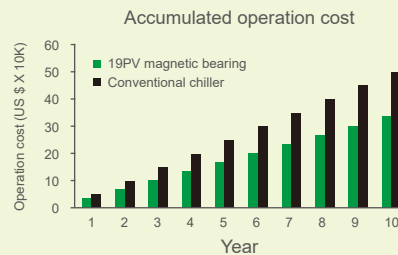

Notes:
The analysis based on the assumption of a office building requires 350RT chiller, total operation hours are 2880 each year from 8am to 8pm, the electricity bill is \$0.164/kWh.

Easy and fast installation

- Compact design
 - The compact chiller design of 19PV offers ease of installation at site.
 - With a width of 1.1-1.3m, the units can pass through standard door openings and only require minimum floor space in the plant room.
- Simplified electrical connections
 - Main circuit breaker with high trip capacity.
 - Transformer supply to the integrated control circuit (400/24 V).
- Simplified water connections
 - Victaulic pipe connections on the evaporator and condenser.
 - Labeled entering and leaving water pipes.
 - Flexible heat exchanger entry and exit connections at factory.
 - Additional heat exchanger passes for special requirements.
- Fast commissioning
 - Comprehensive system operation test at factory prior to the shipment.
 - Quick-test function for step-by-step verification of the instruments, expansion devices and compressors.

Carrier SmartView® Control System - Intelligent Colored Touch Screen

- ✦ 19PV chiller employs Carrier's most advanced Carrier SmartView® controller that delivers distinct capabilities of controlling and monitoring the chiller operations.
- ✦ Equipped with a 10.4 inch high-resolution touch screen, Carrier SmartView® controller offers more user-friendly interface with intuitive graphical operational data in real time, adapts precisely the chiller capacity to building load and provides comprehensive protection.

Reliable Start - up and Operation

- ✦ Carrier SmartView® controller offers password protection to avoid any unauthorized operation.
- ✦ When chiller starts, the controller will activate pre-start process to check parameters such as pressure, temperature, motor status, water flow etc.
- ✦ In addition to the function of monitoring the main operational parameters, trending function provide the visual dynamic parameter curves. The intelligent and dynamic algorithm ensures optimal, effective and reliable chiller operation.
- ✦ The control system provides following comprehensive protection, which guarantees steady chiller operation:
 - Overcurrent.
 - Discharge temperature overheat.
 - Motor temperature overheat.
 - Evaporator and condenser anti-freeze.
 - Low discharge superheat.

Effective Failure Diagnostic

- ✦ Carrier SmartView® control system has more than 100 failure diagnostic function. Users can easily access chiller operation parameters via touch screen. If control system detects failure the alarm will be initiated and related code will be recorded in alarm menu. The alarm records, up to 50, can be automatically saved by control system. Carrier service technician can read and delete alarm records by Carrier service/PCDCT tools.
- ✦ The control system can automatically send out email alarm to customer or service technician.

Intelligent Remote Connection and Control

- Carrier SmartView® control panel supports CCN, BACnet IP, Modbus TCP/IP and Modbus RTU protocols, with which chiller can seamlessly connect with the Building Automation System or the i-Vu™/WebCTRL control network. Moreover, LonWorks, J-Bus and BACnet MSTP is also supported with optional gateway.
- An industrial Internet intelligent protocol module WIFI dongle housed in electrical cabinet has the function of conversion and transmission of data and can connect the field chiller controllers through the wireless network. Chiller operational data can be transmitted to the remote server (Smart Service by Carrier) via wireless network, 4G, etc., so as to monitor chiller data and fault alarm.
- Carrier Smart Service (optional) based on “Big Data Processing” provides value added customer service such as online data management and analysis, daily and key performance reports, prognostics and preventative maintenance and graphic data trend. The enhanced data management and analysis will help achieve continuous optimization of the chiller and system operation.
- Carrier Smart Service changes how equipment is serviced and maintained. Carrier service technicians now utilize mobile devices with remote access to put real-time chiller data and service history in the palm of their hands. With advance notification of problems, technicians arrive at the jobsite more informed, which leads to faster problem resolution and reduced mean time to repair.

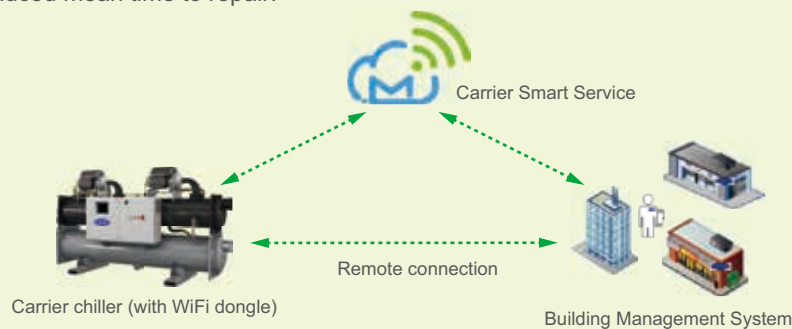

Main Page

- Control system main page operation and primary parameters monitored:
 - Main page button
 - Menu page button
 - Log in/Language button
 - Start-up/Stop page button
 - Alarm menu button
 - Setting point
 - Chiller load percentage
 - Condensing water pump status
 - Chilled water pump status
 - Condenser water inlet/outlet temperature
 - Evaporator water inlet/outlet temperature
- Customer can easily read following primary information of chiller, components status and access to other interfaces from this page:
 - Temperature/Pressure page
 - Input/Output parameter page
 - Water system parameter page
 - Operation time
 - Mode

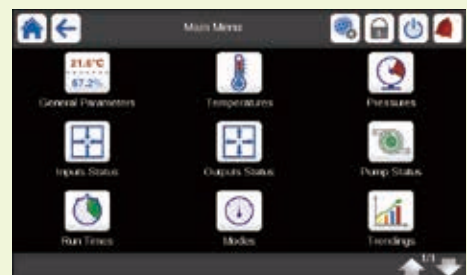

Performance data

Model		19PV						
		19PVH2B3H2C3N32	19PVK2B3K2C3N42	19PVL2B3L2C3N42	19PVOCB3ODB3N62	19PVODB3QDB3N82	19PVOEB3TEB3N82	
Capacity	kW	351.7	527.5	703.4	879.2	1055	1231	
	USRT	100	150	200	250	300	350	
COP @ AHRI	kW/kW	6.337	6.281	5.953	6.185	6.247	6.178	
IPLV @ AHRI	kW/kW	10.61	10.28	11.00	11.31	10.92	11.17	
Evaporator	Flow rate	L/s	15.12	22.68	30.23	37.79	45.35	52.91
	Water Pressure drop	kPa	37.8	47.5	48.7	38.9	47.3	55.1
	Water connection	DN	125	150	150	200	200	200
Condenser	Flow rate	L/s	18.81	28.33	37.86	47.20	56.56	66.01
	Water Pressure drop	kPa	37.4	50.6	50.4	45.8	49.8	47.9
	Water connection	DN	125	150	150	200	200	200
Compressor		Magnetic bearing oil-free centrifugal						
	No.	1	1	1	2	2	2	
Input power	kW	55.49	83.99	118.2	142.2	168.9	199.2	
Refrigerant		HFC-134a						
Refrigerant Charge	kg	215	235	260	430	450	470	
Shipping weight*	kg	2391	2659	3142	4799	5062	5584	
Operation weight	kg	2432	2793	3394	5065	5421	6089	
Dimension	Length	mm	3132	3142	3192	4117	4136	4176
	Width	mm	1157	1210	1210	1268	1291	1322
	Height	mm	1826	1934	2060	2186	2239	2295

Notes:

- Based on AHRI IP condition: Evaporator chilled water outlet temperature 6.67°C , chilled water inlet temperature 12.22°C , fouling factor=0.0176m²K/kW.
Condenser cooling water inlet water temperature 29.44°C , cooling water outlet temperature 34.61°C , fouling factor=0.044m²K/kW.
- Above performance is based on 3 passes and GB pressure vessel heat exchanger design, water side pressure is 1.0MPa, for the requirements of 2 passes or ASME pressure vessel etc. design, please contact Carrier local agencies.
- Above performance is based on the E-Cat selection, the power supply is 400V-3Ph-50Hz, the physical performance data of 380V-3Ph-60Hz chiller is same as above.
- Carrier will select specific models using E-Cat on different requests for tonnage and efficiency, for details or customized selections, please contact Carrier local agencies.
- * The shipment weight is only base unit and wooden crating, excluding refrigerant and water inside.

Options & accessories

Options	Description	Advantages
Condenser insulation	19mm thermal insulation on condenser	Condenser protection
Service valve set	Compressor suction line isolation valve	Easy maintenance
16 bar heat exchangers	Reinforced h.x. for extension of the maximum water-side service pressure to 16 bar (standard 10 bar)	Covers applications with a high water column(high buildings)
21 bar heat exchangers	Reinforced h.x. for extension of the maximum water-side service pressure to 21 bar (standard 10 bar)	Covers applications with a high water column(high buildings)
Marine water box (MWB)	Water box makes the water connection pipe perpendicular to the heat exchanger	Saving the water pipe installation space and easily cleaning the heat exchanger tube
5% Total Harmonic Current Distortion	Unit mounted active harmonic filter with lower 5 % THD offering	Reduce Harmonic, cleaning power source
Control for low condenser temperature systems	Output signal (0-10 V) to control the condenser water inlet valve	Used for applications with cold water at the condenser inlet (well water). In this case the valve controls the water entering temperature to maintain an acceptable condensing pressure
ASME	Heat exchangers design per ASME VIII	Heat exchanger design meet requirements of American Society of Mechanical Engineers and different market/customer demands
Australia code	a. ASME heat exchanger pressure vessel code b. Electrical design per Australia requirement	Meets Australia government pressure vessel code AS 1210 and AS 4343
Flanged evaporator water connection kit	Victaulic piping connections with flanged joints	Easy installation
Flanged condenser water connection kit	Victaulic piping connections with flanged joints	Easy installation
Master/slave operation	Unit equipped with supplementary water outlet temperature sensor kit to be field-installed allowing master/slave operation of two units connected in parallel	Master/slave control to optimize performance of two units in one plant

Electrical parameters

Electrical parameters (400V-3Ph-50Hz)

Models		19PVH2B3H2C3N32	19PVK2B3K2C3N42	19PVL2B3L2C3N42	19PVOCB3ODB3N62	19PVODB3QDB3N82	19VPOEB3TEB3N82
Rated Voltage	V-ph-Hz	400-3-50					
Voltage Range	V	360~440					
Control circuit		24 V per internal transformateur					
Power Factor	A	0.88	0.90	0.91	0.90	0.90	0.91
Maximum current draw	A	170.0	196.0	196.0	340.0	392.0	392.0
Nominal current draw	A	91.50	134.2	186.4	229.5	270.1	315.9

Electrical parameters (380V-3Ph-60Hz)

Models		19PVH2B3H2C3N33	19PVK2B3K2C3N43	19PVL2B3L2C3N43	19PVOCB3ODB3N63	19PVODB3QDB3N83	19VPOEB3TEB3N83
Rated Voltage	V-ph-Hz	380-3-60					
Voltage Range	V	342~418					
Control circuit		24 V per internal transformateur					
Power Factor	A	0.88	0.90	0.91	0.90	0.90	0.91
Maximum current draw	A	170.0	206.0	206.0	340.0	412.0	412.0
Nominal current draw	A	96.31	141.3	196.2	241.6	284.3	332.5

Notes:

- Nominal current draw obtained at AHRI IP condition: evaporator temperature entry/leave water = 12.22°C /6.67°C , condenser temperature entry/leave water = 29.44°C /34.61°C .
- Maximum current draw obtained at operation with maximum unit power input.
- Carrier will select specific models using E-Cat on different requests for tonnage and efficiency, for details or customized selections, please contact Carrier local agencies.

Part load performances

With the rapid increase in energy costs and the care about environmental impacts of electricity production, power consumption of air conditioning equipment has become an important topic. The energy efficiency of a liquid chiller at full load is rarely representative of the actual performance of the units, as on average a chiller works less than 5% of the time at full load.

IPLV (in accordance with AHRI 550/590)

The IPLV (integrated part load value) allows evaluation of the average energy efficiency based on four operating conditions defined by the AHRI. The IPLV is the average weighted value of the Cooling Coefficient of Performance (COP_R) at different operating conditions, weighted by the operating time.

IPLV (integrated part load value)

Load %	Condenser entering water temperature(C)	Energy efficiency	Operating time(%)
100	29.4	COP _{R1}	1
75	23.9	COP _{R2}	42
50	18.3	COP _{R3}	45
25	18.3	COP _{R4}	12

$$\text{IPLV} = \text{COP}_{R1} \times 1\% + \text{COP}_{R2} \times 42\% + \text{COP}_{R3} \times 45\% + \text{COP}_{R4} \times 12\%$$

The heat load of a building depends on many factors, such as the outside air temperature, the exposure to the sun and its occupation. Consequently it is preferable to use the average energy efficiency, calculated at several operating points that are representative for the unit utilisation.

ESEER (in accordance with EUROVENT)

The ESEER (European seasonal energy efficiency ratio) permits evaluation of the average energy efficiency at part load, based on four operating conditions defined by Eurovent. The ESEER is the average value of energy efficiency ratios (EER) at different operating conditions, weighted by the operating time.

ESEER (European seasonal energy efficiency ratio)

Load %	Condenser entering water temperature(C)	Energy efficiency	Operating time(%)
100	30	EER ₁	3
75	26	EER ₂	33
50	22	EER ₃	41
25	18	EER ₄	23

$$\text{ESEER} = \text{EER}_1 \times 3\% + \text{EER}_2 \times 33\% + \text{EER}_3 \times 41\% + \text{EER}_4 \times 23\%$$

Wiring Diagram

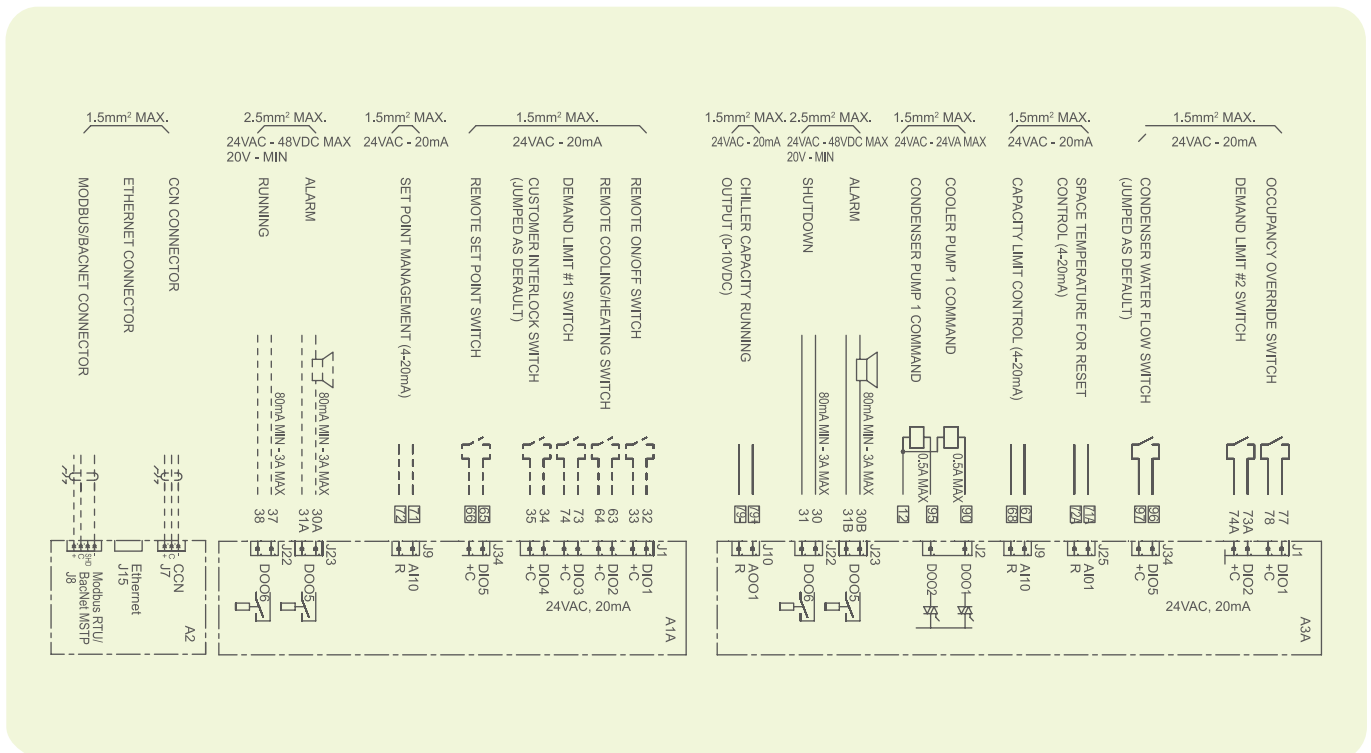

Chiller dimension

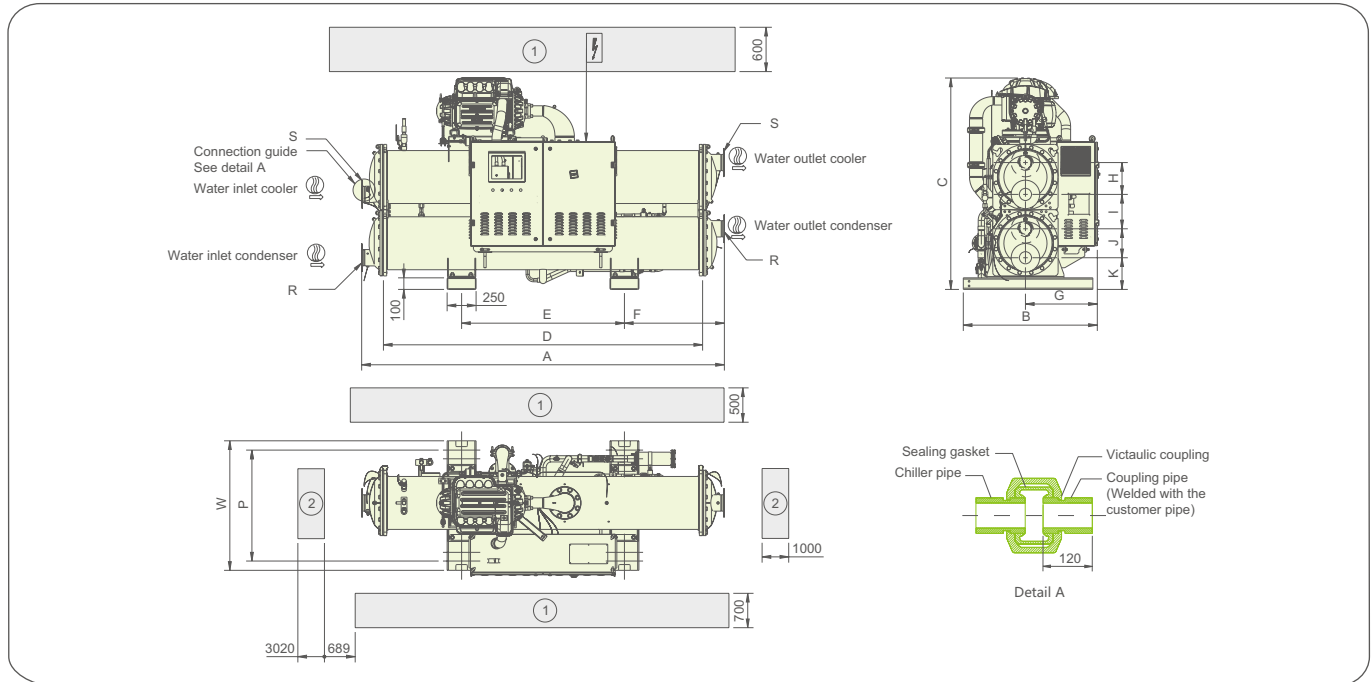

Model	A	B	C	D	E	F	G	H	I	J	K	P	W	S	R
19PVH**3H**3-	3132	1157	1826	2756	1406	863	621	275	297	250	274	958	1119	DN125	DN125
19PVK**3K**3-	3142	1210	1934	2756	1406	868	674	304	318	282	296	1160	1210	DN150	DN150
19PVL**3L**3-	3192	1210	2060	2756	1406	893	673	327	388	280	311	1160	1210	DN150	DN150

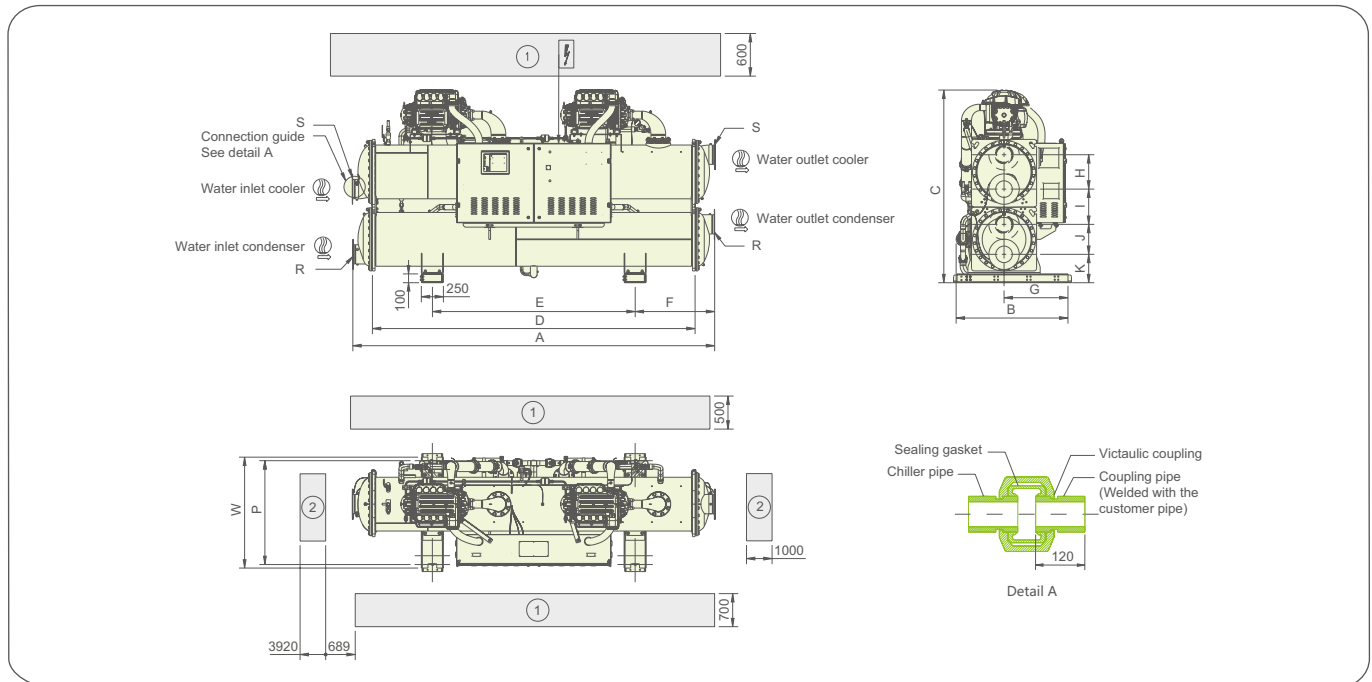

Model	A	B	C	D	E	F	G	H	I	J	K	P	W	S	R
19PVO**3O**3-	4117	1268	2186	3660	2300	908	725	390	400	340	322	1178	1258	DN200	DN200
19PVO**3Q**3-	4136	1291	2239	3660	2300	917	725	390	398	400	318	1178	1258	DN200	DN200
19PVO**3T**3-	4176	1322	2295	3660	2300	937	725	390	446	360	363	1178	1258	DN200	DN200

- Notes:
1. Tolerances on nozzle locations and overall dimensions are ± 25 mm.
 2. ⓂRequired clearances for maintenance, ⓂRecommended space for tube removal (clearance 3020/3290 and 1000 can be either on the right or the left side).
 3. The water pipe connector is the Victaulic coupling and the pipe are supplied with the chiller, the pipe length is 120mm.
 4. Above chiller dimension is based on 3 passes and GB pressure vessel heat exchanger design, for the requirements of 2 passes or ASME pressure vessel etc. design, please contact Carrier local agencies.

Chiller Basement

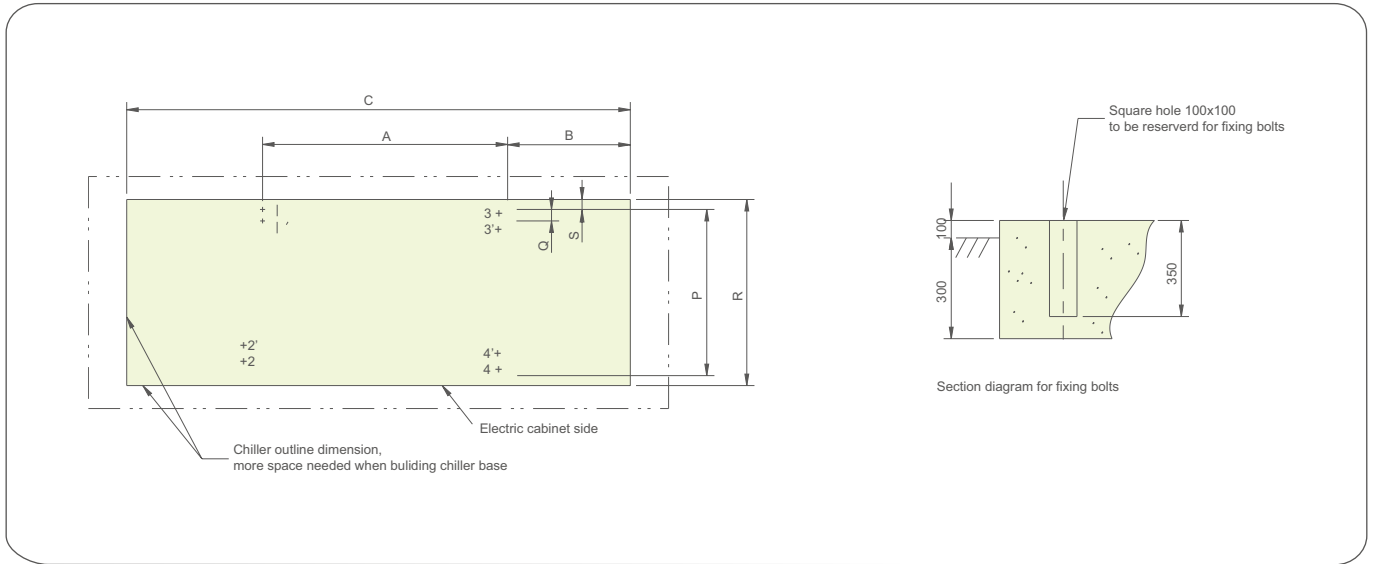

Model	A(mm)	B(mm)	C(mm)	P(mm)	Q(mm)	R(mm)	S(mm)
19PVH**3H**3-	1406	863	3132	958	75	1157	80
19PVK**3K**3-	1406	868	3142	1160	75	1210	25
19PVL**3L**3-	1406	893	3192	1160	75	1210	25
19PVO**3O**3-	2300	908	4117	1178	100	1268	40
19PVO**3Q**3-	2300	917	4136	1178	100	1291	40
19PVO**3T**3-	2300	937	4176	1178	100	1322	40

- Notes:
- 4 bolts used to fix chiller, bolt size M20×300.
 - User can select 1, 2, 3, 4 or 1', 2', 3', 4' as a group to fix bolts.

Recommendations on heat exchange fluids

Filters are required to be installed in water entering side, and water quality analysis periodically implement. Water quality should be maintained within the limits indicated in below table.

Water Characteristics	Quality Limitation
NH ₃	<2 ppm
NH ⁴⁺	<2 ppm
Cl ₂	<1 ppm
Cl ⁻	< 300 ppm
H ₂ S*	<0.05 ppm
SO ₄ ²⁻	< 70 ppm
CO ₂ †	<5 ppm
Fe ²⁺ /Fe ³⁺	<0.2 ppm
O ₂	< 5 ppm

Water Characteristics	Quality Limitation
NO ₃	<100 ppm
Si	< 0.1 ppm
Al	<0.2 ppm
Mn	<0.1 ppm
Hardness	71.2<...<151.3mg/l CaCO ₃
Resistance	>3000ohm.cm
Conductivity	200<...<600µS/cm
Ph	7.5<...<9

Guide Specifications

Applied Magnetic Bearing Centrifugal Liquid Chiller

HVAC Guide Specifications — 19PV

Size Range: 100 to 350 Tons (351 to 1231 kW) Nominal

Carrier Model Number: 19PV

Part 1 — General

1.1 SYSTEM DESCRIPTION

Factory assembled single piece water-cooled liquid chiller. Contained within the unit shall be all factory wiring, piping, controls, refrigerant charge (HFC-134a), refrigeration circuits set, two stage magnetic bearing oil free centrifugal compressor, electronic expansion valves and equipment required prior to field start-up.

1.2 QUALITY ASSURANCE

- A. Chiller performance shall be rated in accordance with the latest edition of AHRI Standard 550/590 (I-P), AHRI Standard 551/591 (SI) and GB/T 18430.1.
- B. Cooler and condenser refrigerant side shall include nameplate certifying compliance with NB/T 47012, pressure vessels for refrigerant equipment.
- C. Chiller shall be designed and constructed to TSG 21-2016 requirements.
- D. The chiller and the unit-mounted VFD shall be factory wired and tested together to verify proper operation prior to shipment.
- F. Unit shall be designed, manufactured and tested in a facility with a quality management system certified ISO 9001 and environmental management system ISO 14001.
- G. Unit components shall be capable of withstanding 60 degC storage without damage, failure, refrigerant loss, or safety risks.

1.3 DELIVERY, STORAGE AND HANDLING

- A. Unit shall be stored and handled in accordance with manufacturer's instructions.
- B. Unit shall be shipped with all refrigerant piping and control wiring factory installed.
- C. Unit shall be shipped with wooden or thermoplastic and wooden base package.
- D. Unit shall be shipped with firmly attached labels that indicate name of manufacturer, chiller model number, chiller serial number, and refrigerant used.
- E. If the chiller is to be exported, the unit shall be sufficiently protected from the factory against sea water corrosion to be suitable for shipment in a standard ocean shipping container.

1.4 WARRANTY

Warranty shall include parts and labor for one year after start-up or 18 months from shipment, whichever occurs first.

Part 2 — Products

A. Compressor:

1. The 19PV has a two stage, semi-hermetic, digitally-controlled magnetic bearing centrifugal compressor requiring no oil for lubrication.
2. Compressor shall be constructed with cast aluminum casing and high strength thermoplastic electronics enclosures. The two-stage centrifugal impellers shall consist of cast and machined aluminum. The motor rotor and impeller assembly shall be the only major moving parts.
3. The compressor shall be provided with a direct drive, high-efficiency, and permanent-magnet synchronous motor powered by pulse-width modulating (PWM) voltage supply. The motor shall be compatible with high-speed variable frequency operation that affords high-speed efficiency, compactness and soft start capability. Motor cooling shall be by liquid refrigerant injection.
4. The compressor shall include a microprocessor controller capable of controlling magnetic bearings and speed control. The controller shall be capable of providing monitoring, including commissioning assistance, energy outputs, operation trends, and fault codes via a Modbus interface.
5. The compressor shall be provided with radial and axial magnetic bearings to levitate the shaft, thereby eliminating metal-to-metal

Guide Specifications

contact, and thus eliminating friction and the need for oil. The magnetic bearing system shall consist of front, rear, and axial bearings. Both the front and the rear bearings are to levitate the shaft at X and Y directions, and the axial at Z direction. Each bearing position shall be sensed by position sensors to provide real-time repositioning of the rotor shaft, controlled by onboard digital electronics.

6. The compressors shall be serviceable for most of its parts in field.
7. The compressor shall have a Variable Frequency Drive (VFD) for linear capacity modulation, high part-load efficiency and reduced in-rush starting current. It shall include an Insulated Gate Bipolar Transistor (IGBT) type inverter that converts the DC voltage to an adjustable three-phase AC voltage. Signals from the compressor controller shall determine the inverter output frequency, voltage and phase, thereby regulating the motor speed. In case of power failure, the compressor shall be capable of allowing for a normal de-levitation and shutdown.
8. Compressor speed shall be reduced as condensing temperature and/or heat load reduces, optimizing energy performance through the entire range of capacity. Capacity modulates infinitely as motor speed is varied across the range. Inlet Guide Vanes (IGVs) shall be built-in to further trim the compressor capacity in conjunction with the variable-speed control to optimize compressor performance at low loads.

B. Cooler and Condenser:

1. Unit shall be equipped with a single cooler and condenser.
2. Cooler and condenser shall be manufactured, tested and stamped in accordance with the NB/T 47012 or ASME Pressure vessel code VIII.
3. The maximum refrigerant-side working pressure will be 1600kPa, and the maximum waterside pressure will be 1000kPa (1600kPa, 2068kPa as options).
4. The cooler and condenser shall be mechanically cleanable, shell-and-tube type with removable heads. Cooler shell shall be insulated with 19mm (38mm as optional) closed-cell foam and factory fitted.
5. Tubing shall be copper, high-efficiency type, with integral internal and external enhancement unless otherwise noted. Tubes shall be nominal 19.0mm OD or 25.4mm OD with nominal wall thickness of 0.635mm measured at the root of the fin at the enhanced areas.
6. The cooler and condenser shall have a drain and vent in each head.
7. The cooler and condenser tubesheet shall be aluminum coating on water side for better anti-corrosion effect.
8. Two reseating type pressure relief valves shall be installed on each cooler and condenser.
9. The cooler shall incorporate an active refrigerant level control system to ensure optimum heat transfer performance under all load conditions.
10. Cooler and condenser shall have water inlet & outlet connection with victaulic couplings to avoid vibrations transmission and accept small misalignment (water connection kit on demand).
11. Cooler shall be fitted with electronic auto setting water flow switch. Paddle switches or differential pressure switches shall not be acceptable.

C. Refrigerant Flow Control:

To improve part load efficiency, liquid refrigerant shall be metered from the condenser to the cooler using electronic expansion valve to maintain the proper liquid level of refrigerant in the heat exchangers under both full and part load operating conditions.

D. Controls, Safeties, and Diagnostics:

D.1 Controls:

- a. The chiller shall be provided with a factory installed and wired microprocessor control center. The control center shall include a 10.4" colorful touch screen, two basic SIOBs and optional AUX board per system requirements. The microprocessor can be configured for either English or SI units.
- b. All chiller and compressor monitoring shall be displayed at the chiller Carrier SmartView[®] touch screen.
- c. The controls shall make use of non-volatile memory.
- d. The chiller control system shall have the ability to interface and communicate directly to the building control system. Native BACnet and Modbus protocol are supported.
- e. The default standard display screen shall simultaneously indicate the following minimum information:

Guide Specifications

- 1) Date and time of day
- 2) Synoptic screen access button
- 3) Main Menu access button
- 4) User Login screen access button
- 5) Alarm menu access button
- 6) Setpoint
- 7) Discharge pressure
- 8) Sub Cooling pressure
- 9) Main Suction Pressure
- 10) Entering chilled water temperature
- 11) Leaving chilled water temperature
- 12) Compressor Suction temperature
- 13) Entering condenser water temperature
- 14) Leaving condenser water temperature
- 15) Discharge Gas temperature
- 16) Sub cooling temperature
- 17) Compressor Status

f. Schedule Function:

The chiller controls shall be configurable for manual or automatic start-up and shutdown. In automatic operation mode, the controls shall be capable of automatically starting and stopping the chiller according to a stored user programmable occupancy schedule. The controls shall include built-in provisions for accepting:

- 1) 365-day occupancy schedules.
- 2) Minimum of 8 separate occupied/unoccupied periods per day.
- 3) Daylight savings start/end.
- 4) 16 user-defined holidays.
- 5) Means of configuring occupancy timed override.
- 6) Chiller start-up and shutdown via remote contact closure.

g. Service Function:

The controls shall provide a password protected service function which allows authorized individuals to view an alarm history file which shall contain the last 20 alarm/alert messages with time and date stamp. These messages shall be displayed in text form, not codes.

h. Network Window Function:

Each chiller control panel shall be capable of viewing multiple point values and statuses from other like controls connected on a common network, including controller maintenance data. The operator shall be able to alter the remote controller's set points or time schedule and to force point values or statuses for those points that are operator forcible. The control panel shall also have access to the alarm history file of all like controllers connected on the network.

i. Pump Control:

Upon request to start the compressor, the control system shall start the chilled water pump, condenser water pumps and verify that flows have been established.

j. Chilled Water Reset:

The control center shall allow reset of the chilled water temperature set point based on any one of the following criteria:

- 1) Chilled water reset based on an external 4 to 20 mA signal.
- 2) Chilled water reset based on a remote temperature sensor (such as outdoor air).
- 3) Chilled water reset based on water temperature rise across the evaporator.

D.2 Safeties:

a. Unit shall automatically shut down when any of the following conditions occur: (Each of these protective limits shall require manual reset and cause an alarm message to be displayed on the control panel screen, informing the operator of the shutdown cause.)

- 1) Transducer Failure
- 2) Low evaporator refrigerant temperature
- 3) Cabinet Thermostat Failure

Guide Specifications

- 4) High compressor discharge temperature
- 5) Sub cooling Failure
- 6) High Superheat Failure
- 7) Low Superheat Failure
- 8) High Pressure Switch Failure
- 9) Loss of cooler water flow
- 10) Loss of condenser water flow
- 11) Starter fault

b. Compressor shall automatically shut down when any of the following conditions occur: (Each of these protective limits shall cause an alarm message to be displayed on the control panel screen, informing the operator of the shutdown cause.)

- 1) Compressor related transducer failure
- 2) High motor temperature (Inverter, SCR, BMCC, Cavity temperature etc.)
- 3) Over motor current
- 4) Low Suction pressure.
- 5) High Discharge Pressure

c. Internal built-in safeties shall protect the chiller from loss of water flow. Flow switch option is supplied by chiller manufacturer. Differential pressure switches shall not be allowed to be the only form of freeze protection.

D.3 Diagnostics and Service:

A self-diagnostic controls test shall be an integral part of the control system to allow quick identification of malfunctioning components. Once the controls test has been initiated, all pressure and temperature sensors shall be checked to ensure they are within normal operating range. A chilled pump test shall energize the chilled water pump, and the control system shall confirm that water flow have been established and require operator confirmation before proceeding. Perform the condenser water pump test in this way, too.

In addition to the automated controls test, the controls shall provide a manual test which permits selection and testing of individual control components and inputs. A thermistor test and transducer test shall display on the Carrier SmartView® touch screen the actual reading of each transducer and each thermistor installed on the chiller. All out-of-range sensors shall be identified.

D.4 Multiple Chiller Control:

The chiller controls shall be supplied with two chiller lead/lag system. The control system shall automatically start and stop a lag or second chiller on a two-chiller system.

E. Electrical

1. Power connection shall be single point to a factory-mounted MCCB.
2. Each compressor equips an EMC/EMI filter which can minimize the harmonics in the high frequency domain (typically above 1 kHz). It is for IEC61800-3 Category C3 compliance.
3. Each compressor equips a 4% impedance line reactor between the motor drive power circuits and the AC line power. The line reactors provide additional circuit impedance that improves power factor, reduces line current harmonics, and dampens the transient voltages on the power line.

F. Start-up:

1. The chiller manufacturer shall provide a factory-trained representative, employed by the chiller manufacturer, to perform the start-up procedures as outlined in the Installation, Operation and Maintenance manual provided by the chiller manufacturer.
2. Manufacturer shall supply the following literature:
 - a. Installation, operation and maintenance instructions.
 - b. Field wiring diagrams.
 - c. One complete set of pressure vessel assemble-built drawings.

Guide Specifications

G. Special Features:

1. Carrier Comfort Network (CCN over IP): The chiller can be controlled by commands from the Carrier Comfort Network. In this case a data communication cable is used to connect the unit to the CCN communication bus.
2. Hot Gas Bypass
Hot gas bypass enables the system to operate at lower load by bypassing the expansion valve, therefore extending the chiller minimum cooling capacity.
3. Thermal Insulation:
Unit manufacturer shall insulate the cooler shell, cooler tube sheet, suction piping, water box, compressor, copper lines. Insulation shall be 19 mm or 38mm.
4. Cooler and Condenser Passes:
Unit manufacturer shall provide the cooler and/or condenser with 2 or 3 pass configuration on the water side.
5. Nozzle-In-Head, 1034 kPa:
Unit manufacturer shall furnish nozzle-in-head style waterboxes on the cooler and/or condenser rated at 2068 kPa
6. Nozzle-In-Head, 2068 kPa:
Unit manufacturer shall furnish nozzle-in-head style waterboxes on the cooler and/or condenser rated at 2068 kPa.
7. Flanged Water Nozzles:
Unit manufacturer shall furnish optional flanged piping connections on the cooler and/or condenser.
8. EMM
The Energy management is a standard function for 19PV unit. This functionality provides additional inputs and outputs for further information and switch controls.

It offers:

3 additional Analogic inputs:

- Space temperature for reset control (SIOB2-AI01)
- Setpoint reset control (SIOB1-AI10)
- Capacity limit control (SIOB2-AI10)

1 additional Analogic output:

- Chiller capacity running output (SIOB2-AO01)

3 Customer Digital inputs:

- Occupancy override switch: In Remote mode closing this switch sets occupancy to yes. (SIOB2-DI01)
- 2nd capacity limit switch: In remote mode enables the 2nd capacity limit setpoint (SIOB2-DI02)
- Customer Remote interlock: opening this input creates an alarm and stops the unit. (SIOB1-DI4)

1 Digital input:

- Condenser flow: Detect a flow on condenser side. It should be closed to authorize the unit to start. (SIOB2-DI05)

1 Digital outputs:

- Circuit A running status: should be closed if compressor A is running. (SIOB1-DO06)



Carrier improves the world around us; Carrier improves people's lives; our products and services improve building performance; our culture of improvement will not allow us to rest when it comes to the environment.



www.carrier.com

The Manufacturer reserves the right to change any product specifications without prior notices
© All Rights Reserved Carrier

Version:	CAT_19PV_E_202101-04
Supersede:	CAT_19PV_E_202008-03
Effective date:	Jan, 2021